

SCREENED VENT

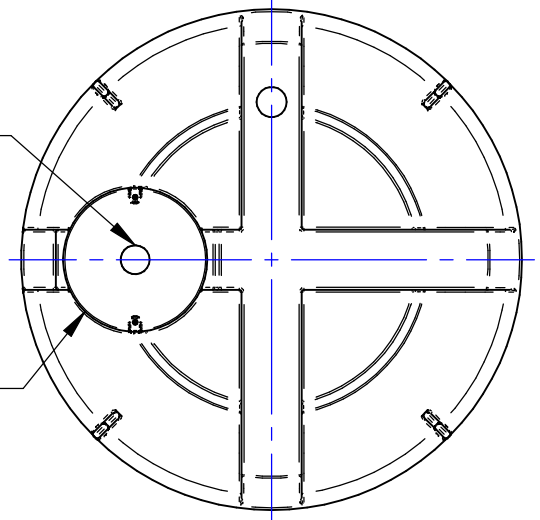

600MM DIA. LID
BOLTED DOWN
MIN. 480MM DIA. OPENING

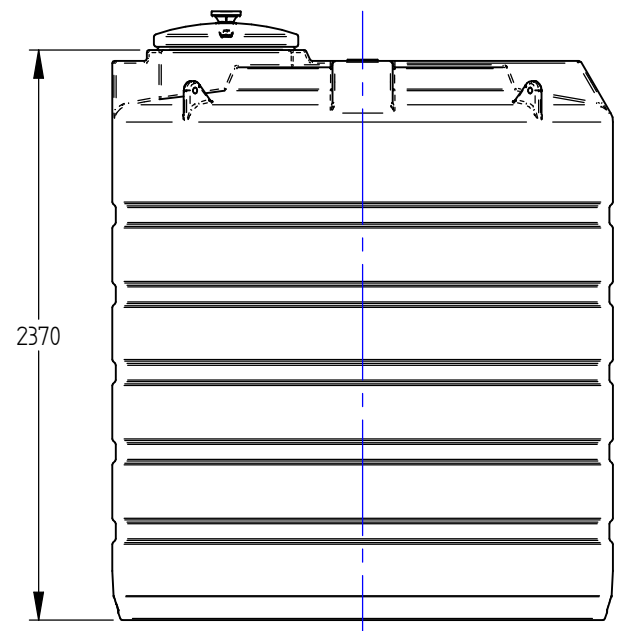
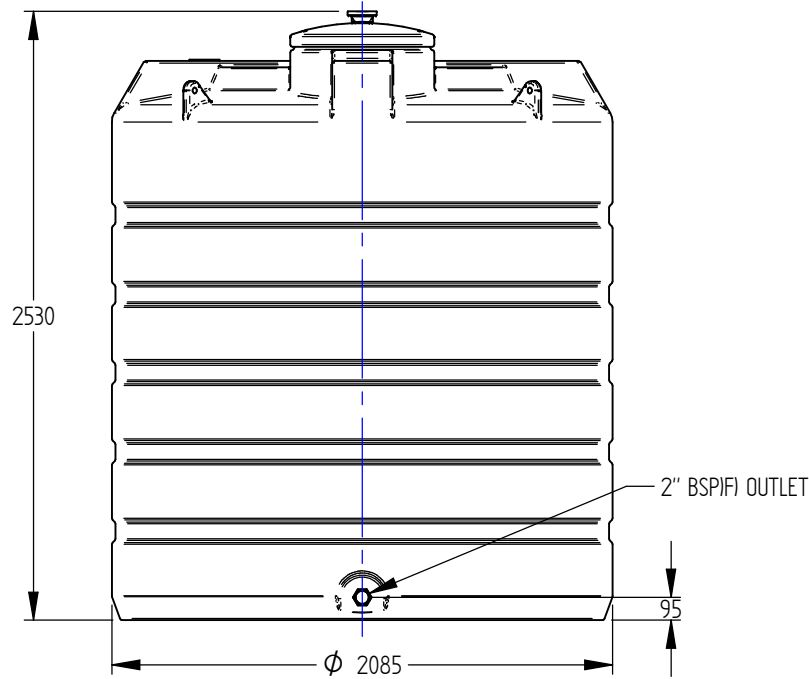

Revision	Issue Date	ELN Reference

THE INFORMATION, DATA, AND DRAWINGS EMBODIED IN THIS DOCUMENT ARE STRICTLY CONFIDENTIAL AND ARE SUPPLIED WITH THE UNDERSTANDING THAT THEY WILL NOT BE DISCLOSED TO ANY THIRD PARTIES WITHOUT THE PRIOR WRITTEN CONSENT OF HARLEQUIN MANUFACTURING LTD
COPYRIGHT Sole property of Harlequin Manufacturing Ltd. All rights reserved

UNLESS OTHERWISE SPECIFIED: DIMENSIONS ARE IN MM
LINEAR TOLERANCE ± 0.25mm, ANGLES ±0.5°
DO NOT SCALE DRAWING - Use Figure Dimensions Only
IF IN DOUBT, ASK

TITLE: **7500LT Water Tank**
NOTES:

DWG NO: 11-015-001	ISSUE DATE: 01/10/2015
REVISION: 00	DRAWN BY: RC
SHEET: 1 of 1	
FILE NAME: 7500LT Water Tank.dft	

Harlequin
MANUFACTURING FOR TOMORROW

Harlequin Manufacturing Ltd
21 Clarehill Road
Moira
Co. Armagh
BT67 0PB
www.harlequin-mfg.com