

High-pressure In-line Pump

Movitec

50 Hz

Type Series Booklet



Legal information/Copyright

Type Series Booklet Movitec

All rights reserved. The contents provided herein must neither be distributed, copied, reproduced, edited or processed for any other purpose, nor otherwise transmitted, published or made available to a third party without the manufacturer's express written consent.

Subject to technical modification without prior notice.

© KSB SE & Co. KGaA, Frankenthal 13/03/2018

Contents

High-pressure Pumps..... 5

 High-pressure In-line Pumps..... 5

 Movitec..... 5

 Main applications..... 5

 Fluids handled..... 5

 Operating data..... 5

 Design details..... 5

 Designation..... 6

 Materials..... 8

 Coating and preservation..... 9

 Product benefits..... 9

 Product information as per Regulation No. 547/2012 (for water pumps with a maximum shaft power of 150 kW) implementing "Ecodesign" Directive 2009/125/EC..... 9

 Certifications..... 9

 Acceptance tests and warranty..... 9

 Selection Information..... 11

 Impeller for lower NPSH values..... 11

 Information about the characteristic curve..... 12

 Fluid handled..... 12

 Minimum flow rate and maximum flow rate..... 12

 Overview of product features / selection tables..... 14

 Table of fluids handled..... 14

 Shaft seal..... 17

 Pressure limits and temperature limits..... 18

 Movitec A, B..... 18

 Technical data..... 19

 Motors..... 19

 Types of connection..... 20

 Terminal box positions..... 20

 Selection Charts..... 21

 Movitec, n = 2900 rpm..... 21

 Movitec, n = 1450 rpm..... 22

 Characteristic curves..... 23

 n = 2900 rpm..... 24

 Movitec, 2B, n = 2900 rpm..... 24

 Movitec, 2LB, n = 2900 rpm..... 25

 Movitec, 4B, n = 2900 rpm..... 26

 Movitec, 4LB, n = 2900 rpm..... 27

 Movitec, 6B, n = 2900 rpm..... 28

 Movitec, 6LB, n = 2900 rpm..... 29

 Movitec, 10B, n = 2900 rpm..... 30

 Movitec, 10LB, n = 2900 rpm..... 31

 Movitec, 15B, n = 2900 rpm..... 32

 Movitec, 15LB, n = 2900 rpm..... 33

 Movitec, 25B, n = 2900 rpm..... 34

 Movitec, 40B, n = 2900 rpm..... 35

 Movitec, 60B, n = 2900 rpm..... 36

 Movitec, 90B, n = 2900 rpm..... 37

 Movitec, 125B, n = 2900 rpm..... 38

 Movitec, LHS 6, n = 2900 rpm..... 39

 n = 1450 rpm..... 40

 Movitec, 10B, n = 1450 rpm..... 40

 Movitec, 10LB, n = 1450 rpm..... 41

 Movitec, 15B, n = 1450 rpm..... 42

 Movitec, 15LB, n = 1450 rpm..... 43

 Movitec, 25B, n = 1450 rpm..... 44

 Movitec, 40B, n = 1450 rpm..... 45

 Movitec, 60B, n = 1450 rpm..... 46

 Movitec, 90B, n = 1450 rpm..... 47

 Dimensions..... 48

 Movitec, 2(L)B, n = 2900 rpm..... 48

 Movitec, 4(L)B, n = 2900 rpm..... 49

 Movitec, 6(L)B, n = 2900 rpm..... 50

 Movitec, 10(L)B, n = 1450 rpm..... 51

Movitec, 10(L)B, n = 2900 rpm.....	52
Movitec, 15(L)B, n = 1450 rpm.....	53
Movitec, 15(L)B, n = 2900 rpm.....	54
Movitec, 25B, n = 1450 rpm.....	55
Movitec, 25B, n = 2900 rpm.....	56
Movitec, 40B, n = 1450 rpm.....	57
Movitec, 40B, n = 2900 rpm.....	58
Movitec, 60B, n = 1450 rpm.....	59
Movitec, 60B, n = 2900 rpm.....	60
Movitec, 90B, n = 1450, 2900 rpm.....	61
Movitec, 125B, n = 2900 rpm.....	62
Movitec, LHS 6, n = 2900 rpm.....	62
Installation information.....	63
Scope of supply.....	65
Accessories.....	65
General assembly drawing with list of components.....	66
Movitec 2(L)B, 4(L)B, 6(L)B.....	66
Movitec 10(L)B, 15(L)B.....	67
Movitec 25B, 40B, 60B.....	68
Movitec 90B.....	69
Movitec 125B.....	70
Movitec LHS 6.....	71

High-pressure Pumps

High-pressure In-line Pumps

Movitec



Main applications

- Spray irrigation systems
- General irrigation systems
- Washing plants
- Fire-fighting systems
- Pressure boosting
- Industrial plants
- Water supply systems
- Heating, ventilation and air-conditioning systems
- Marine applications

Fluids handled

- High-temperature hot water
- Clear water
- Condensate
- Cooling water
- Fire-fighting water
- Oil
- Cleaning agents
- And others (⇒ Page 14)

Operating data

Operating properties

Characteristic	Value		
		Movitec A	Movitec B
Flow rate	Q [m ³ /h]	≤ 8,6	≤ 160
	Q [l/s]	≤ 2,4	≤ 44,4
Head	H [m]	≤ 401	≤ 249
Fluid temperature	T [°C]	≥ -15	≥ -20
		≤ +120	≤ +140 ¹⁾
Operating pressure	p [bar]	≤ 40 ²⁾	≤ 40 ²⁾

Design details

Design

- High-pressure in-line pump
- Maximum pressure class PN 40
- Centrifugal pump
- Single-stage or multistage

Installation

Standard:

- Vertical installation

Optional:

- Horizontal installation

Drive

- Surface-cooled KSB squirrel-cage motor
- 3~230/400 V up to 2.2 kW
- 3~400/690 V from 3.0 kW
- Thermal class F to IEC 34-1
- Efficiency class IE3 to IEC 60034-30 (for three-phase motors ≥ 0.75 kW)
- Enclosure IP55
- Frequency 50 Hz

For VM version and motor designs V18 and V1 ≥ 3 kW:

- PTC thermistors

Shaft seal

- Uncooled maintenance-free mechanical seal
- To EN 12756
- Fixed mechanical seal
 - Mechanical seal in standard design
 - Unbalanced bellows-type seal
 - ≤ 25 bar
 - Fitted as standard for Movitec 2B, 4B, 6B, 10B, 15B
- Easy Access mechanical seal
 - Easy to replace
 - Unbalanced bellows-type seal
 - ≤ 25 bar
 - Drive lantern need not be removed to replace the seal.
 - Motor rating 5.5 kW and above: Motor need not be removed.
 - Fitted as standard for Movitec 25B, 40B, 60B, 90B

1) For operating temperatures > 120 °C the pressure class must not exceed PN 25.
 2) The sum of inlet pressure and shut-off head must not exceed the value indicated.

- Cartridge mechanical seal
 - Unbalanced bellows-type design (PN 25) or special balanced design (PN 40)
 - Drive lantern need not be removed to replace the seal.
 - Motor rating 5.5 kW and above: Motor need not be removed.
- Optionally available for all sizes except Movitec LHS 6
- Standard design for all sizes

Bearings

- Tungsten carbide plain bearings at the hydraulic rotor

Designation

Designation example

Position																															
1	2	3	4	5	6	7	8	9	10	11	12	13	14	15	16	17	18	19	20	21	22	23	24	25	26	27	28	29	30	31	32
M	o	v	i	t	e	c	V		F	0	0	6	/	0	6	1	B	3	D	1	3	E	S	1	1	2	B	7	D	A	X
See name plate and data sheet																		See data sheet													

Designation key

Position	Code	Description
1-7	Pump type	
	Movitec	Movitec
8-9	Variant	
	LH	Stainless steel 1.4404
	V	Stainless steel 1.4301
	VC	Stainless steel / grey cast iron 1.4301 / EN-GJL-250
	VM	Stainless steel 1.4301
10	VS	Stainless steel 1.4404
	Connection type	
	³⁾	Oval flange
	E ⁴⁾	External thread
	F	Round flange
	S	Round flange
11-13	T	Tri-Clamp fitting
	V	Victaulic coupling
	Size	
	002	2
15-16
	125	125
	Number of stages	
17	01	1

	30	30
	Number of stages with special impeller	
18	-	No stage with a special impeller
	1	One stage with a smaller impeller
	2	Two stages with a smaller impeller
	L	One stage with a special impeller for lower NPSH values
19	Product generation	
	A	Movitec up to 2009
	B	Movitec from 2010
19	Connection standard	
	0	Victaulic coupling No standard
	1	Round flange EN 1092
	2	Round flange ASME B16.1
	3	Round flange JIS B2238
	4	Oval flange EN ISO 228-1
	5	Oval flange ASME B16.5
	6	Tri-Clamp fitting DIN 32676
	7	External thread EN ISO 228-1
8	Oval flange ISO 7-1	

3) Blank

4) Pumps with external thread are supplied with an integrated swing check valve as standard.

Position	Code	Description
19	9	Round flange ASME B16.5
20	Material variant	
	D	1.4308 - EN-GJS-400-15 - EN-GJL-250
	E	1.4308 - EN-GJS-400-15 - 1.4308
	F	1.4308 - 1.4308 - EN-GJL-250
	G	1.4308 - 1.4308 - EN-GJS-400-15
	H	1.4308 - 1.4308 - 1.4308
	K	1.4308 - 1.4408 - EN-GJS-400-15
	L	1.4308 - 1.4408 - EN-GJL-250
	M	1.4308 - 1.4408 - 1.4308
	N	1.4308 - EN-GJS-400-15 - EN-GJL-250
	O	1.4408 - EN-GJS-400-15 - 1.4308
	P	1.4408 - 1.4308 - EN-GJL-250
	Q	1.4408 - 1.4308 - 1.4308
	R	1.4408 - 1.4408 - EN-GJL-250
	S	1.4408 - 1.4408 - EN-GJS-400-15
	T	1.4408 - 1.4408 - 1.4308
	U	EN-GJL-250 - EN-GJL-250 - EN-GJL-250
	V	EN-GJS-400-15 - EN-GJS-400-15 - EN-GJS-400-15
	W	EN-GJS-400-15 - 1.4308 - EN-GJS-400-15
	X	1.4308 - EN-GJS-400-15 - EN-GJS-400-15
Y	1.4408 - EN-GJS-400-15 - EN-GJS-400-15	
Z	1.4408 - 1.4308 - EN-GJS-400-15	
21-22	Seal code	
	11	BQ1EGG
	12	BQ1VGG
	13	Q1BEGG
	14	Q1BVGG
	15	U3U3X4GG
	16	U3U3VGG
	18	U3BEGG
	20	Q1AEGG
	21	Q1AVGG
	22	Q1AX4GG
	23	Q1BEGG
	24	Q1Q1VGG
	28	Q1Q1X4GG
	29	Q1Q1EGG
	35	eCarb-B eSic-Q7EGG
36	eCarb-B eSic-Q7VGG	
39	eCarb-B eSic-Q7EGG	
23	Mechanical seal design	
	F	Fixed mechanical seal
	E	Easy Access mechanical seal
	C	Cartridge mechanical seal
24	Drive	
	0	Without motor
	2	With PumpDrive 2
	A	ATEX IEC
	D	With PumpDrive Basic
	E	With PumpDrive 2 Eco
	G	With PumpDrive Advanced
	N	Standard NEMA
	P	With PumpDrive
S	Standard IEC	
25-27	Motor size	
	056	NEMA 56C
	071	IEC 071
	080	IEC 080
	090	IEC 090
	100	IEC 100

Position	Code	Description
25-27	112	IEC 112
	132	IEC 132
	143	NEMA 143TC
	145	NEMA 145TC
	160	IEC 160
	180	IEC 180
	182	NEMA 182TC
	184	NEMA 184TC
	200	IEC 200
	215	NEMA 215TC
	225	IEC 225
	256	NEMA 256TC
	284	NEMA 284TC
	286	NEMA 286TC
	324	NEMA 324TC
326	NEMA 326TC	
364	NEMA 364TC	
28	Pressure class	
	A	PN16 / PN25
	B	PN25
	C	PN25 / PN40
29	Number of motor poles	
	5	50 Hz, 2 poles
	6	60 Hz, 2 poles
	7	50 Hz, 4 poles
30	Motor specification	
	F	EXM IEC - TBH
	G	EXM NEMA
	K	EXM IEC - Movitec
	M	230 V, single-phase AC motor
	O	0.37/0.55 [kW], without IE classification
	U	230/400 V - IE3
	V	400/690 V - IE3
	W	230/400 V - IE4/IE5 (KSB SuPremE)
X	400/690 V - IE4/IE5 (KSB SuPremE)	
31	PumpMeter	
	A	Mit PumpMeter
	W	Without PumpMeter
32	Variant	
	_)3)	Standard
	X	Non-standard (BT3D, BT3)

Materials

Overview of pump component materials depending on the design

Part No.	Description	Design			
		V	VC	VS	LHS 6
10-6	Pump shroud	1.4301		1.4404	
101	Pump casing	1.4308	EN-GJL-250	1.4408	
108	Stage casing	1.4301 ⁵⁾ / 1.4308 ⁶⁾		1.4404 ⁵⁾ / 1.4408 ⁶⁾	
160	Discharge cover	1.4301 ⁵⁾ / 1.4308 ⁶⁾		1.4404 ⁵⁾ / 1.4408 ⁶⁾	
210	Shaft	1.4057		1.4460	
230	Impeller ⁷⁾	1.4301 ⁵⁾ / 1.4308 ⁶⁾		1.4404 ⁵⁾ / 1.4408 ⁶⁾	

5) Movitec 2B, 4B, 6B, 10B, 15B, 25B, 40B, 60B

6) Movitec 90B, 125B

7) The impellers of Movitec 125 are made of sheet metal and cast material.

Part No.	Description	Design			
		V	VC	VS	LHS 6
341	Drive lantern	EN-GJL-250 ⁸⁾ / EN-GJS-400-15 ⁹⁾			
412	O-ring	EPDM-WRc / ACS / ACS	EPDM	FPM / HNBR	
525	Spacer sleeve	1.4301		1.4401	
529	Bearing sleeve	Tungsten carbide / aluminium oxide			
890	Baseplate	EN-GJS-400-15 / EN-GJL-250 / 1.4308 ¹⁰⁾	-	EN-GJS-400-15 / EN-GJL-250 / 1.4308 ¹⁰⁾	
905	Tie bolt	1.4057			
920	Nut	1.4301		1.4404	
932	Circlip	1.4571			

Comparison of materials

EN	ASTM
EN-GJL-250	A48 Class 35 B
EN-GJS-400-15	A5369 Grade 60-40-18
1.4057	SS 431
1.4301	SS 304
1.4308	Grade CF8M
1.4404	SS 316L
1.4408	Grade CF8M
1.4460	SS 329
1.4571	SS 316Ti

Coating and preservation

Coating of pump components

Component	Coating
Stainless steel components	No additional coating
Movitec VC:	
Pump casing made of grey cast iron	Cataphoretic coating
Movitec V/VS:	
Slide flanges made of grey cast iron	Cataphoretic coating
Drive lantern made of grey cast iron	Powder coating

Product benefits

- Reliable: product-lubricated plain bearings made of tungsten carbide, cast pump foot, torsion-resistant pump shroud and confined O-rings
- Long service life: corrosion-resistant hydraulic components made of stainless steel
- Easy to service: can be fitted with any standardised mechanical seal (to EN 12756)
- Flexible: various materials and connection options, extended temperature range and pressure range

Product information as per Regulation No. 547/2012 (for water pumps with a maximum shaft power of 150 kW) implementing "Ecodesign" Directive 2009/125/EC

- Minimum efficiency index: see data sheet
- The benchmark for the most efficient water pumps is MEI ≥ 0.70 .
- Year of construction: see data sheet

- Manufacturer's name or trade mark, commercial registration number and place of manufacture: see data sheet or order documentation
- Product's type and size identifier: see data sheet
- Hydraulic pump efficiency (%) with trimmed impeller: see data sheet
- Pump performance curves, including efficiency characteristics: see documented characteristic curve
- The efficiency of a pump with a trimmed impeller is usually lower than that of a pump with full impeller diameter. Trimming of the impeller will adapt the pump to a fixed duty point, leading to reduced energy consumption. The minimum efficiency index (MEI) is based on the full impeller diameter.
- Operation of this water pump with variable duty points may be more efficient and economic when controlled, for example, by the use of a variable speed drive that matches the pump duty to the system.
- Information relevant for disassembly, recycling or disposal at end of life: see installation/operating manual
- Information on benchmark efficiency or benchmark efficiency graph for MEI = 0.70 (0.40) for the pump based on the model shown in the Figure are available at: <http://www.europump.org/efficiencycharts>

Certifications

Overview

Label	Effective in:	Comment
	France	French drinking water approval
	United Kingdom	-

Acceptance tests and warranty

- Pressure test
 - to EN 809
- Leak test
 - with water
- Materials testing
 - Certificate of compliance with the order (corresponds to EN 10204)
In the certificate of compliance with the order the manufacturer confirms by way of an informal report without specifying test results that the delivery complies with the stipulations of the purchase order.
 - Test report 2.2 on request
- Final inspection
 - Inspection certificate 3.1 to EN 10204 on request

8) Movitec 2B, 4B, 6B, 10B, 15B, 25B (≤ 4 kW) and Movitec 90B

9) Movitec 2B, 4B, 6B, 10B, 15B, 25B (≥ 5.5 kW) and Movitec 40B, 60B, 125B

10) Optional for: Movitec 2B, 4B, 6B, 10B, 15B

- **Hydraulic test**
The duty point of each pump is guaranteed to ISO 9906:2012 Grade 3B.
This test is always carried out using the original motor.
The NPSH and the suction lift are not measured (3.2 certificate available).
- **Warranties**
Warranties are given within the scope of the valid terms and conditions of sale and delivery.

Selection Information

Impeller for lower NPSH values

An impeller for lower NPSH values is available for sizes 2, 4, 6, 10 and 15.

This type of impeller ensures that the pump's NPSH curve is significantly improved.

The solution is based on a newly developed impeller for lower NPSH values and a modified stage casing. Cavitation inside the pump can hence be prevented in the case of critical inlet conditions.

Risks of cavitation:

- Reduced lifetime of the pump due to damaged parts and unbalanced hydraulic system
- Excessive wear of pump parts or motor bearings
- Insufficient cooling and/or lubrication of the mechanical seal and pump bearing

Benefits of using impellers for lower NPSH values:

- More suitable in critical inlet conditions
- Easy adaptation to non-optimised application parameters
- The suction lift (H_p) is less crucial (the frame height of the degassing tank used in boiler feeding can be reduced).

Consequences of using impellers for lower NPSH values:

- No need to change pump installation heights or pump nozzles
- Minor adjustments to the characteristic curve

Calculation:

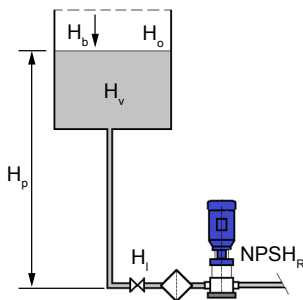

$$NPSH_A \geq NPSH_R + H_z$$

$$NPSH_A = H_b + H_o + H_p - H_v - H_l$$

$$x = H_b + H_o + H_p - H_v - H_l - NPSH_R - H_z$$

$$x \geq 0$$

Fig. 1: Calculating the $NPSH_A$

$NPSH_A$	NPSH system value at operating point
$NPSH_R$	NPSH pump value at operating point (see characteristic curve of the pump)
H_b	Atmospheric pressure [mWc]
H_o	Positive pressure (with tank closed)
H_p	Suction lift [mWc]
H_v	Vapourisation pressure [mWc] (see vapourisation pressure diagram for water)
H_l	Friction losses in pipes and accessories [mWc]
H_z	Safety margin (min. 0,5 m)
x	Minimum pressure

Result:

If the minimum pressure (x) is positive, there is no risk of cavitation.

If the minimum pressure (x) is negative, there is a risk of cavitation which can be avoided by using an impeller for lower NPSH values.

Another option is to change one of the other values so that the value becomes positive.

Example:

- Boiler feed water: 105 °C
- Positive height of tank: 2 m
- Positive pressure in tank: 3 mWc
- Flow rate: 5 m³/h
- Head: 100 m (10 bar)
- Size selected: 4

Calculation of positive pressure on suction flange:

Calculation of positive pressure on suction flange:	Standard impeller	Special impeller for lower NPSH values
Atmospheric pressure [mWc]	10,3	10,3
Positive pressure (with tank closed)	3,0	3,0
Suction lift	2,0	2,0
Vaporisation pressure [mWc] (see water vaporisation pressure diagram)	-12,5	-12,5
Friction losses in pipes and accessories [mWc]	-1,0	-1,0
Safety margin (min. 0,5 m)	-0,5	-0,5
NPSH pump value at operating point (see characteristic curve of the pump)	-2,1	-0,8
Minimum pressure	-0,8	+0,5
Conclusion	Cavitation will occur.	No cavitation

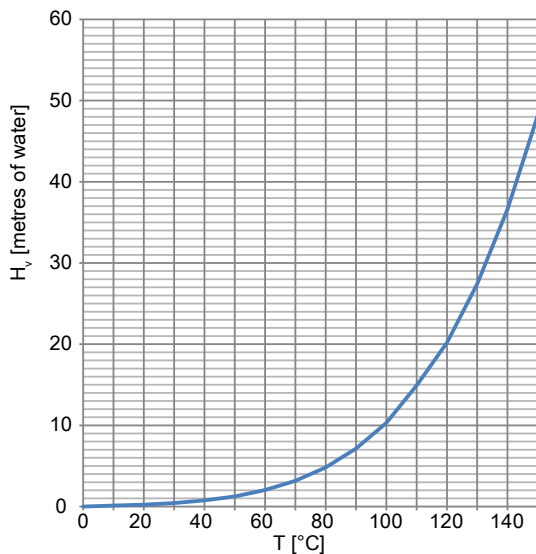

Fig. 2: Vaporisation pressure diagram (H_v) for water

Information about the characteristic curve

NPSH [m], [ft]:

- The NPSH values given in the individual characteristic curves are minimum values which correspond to the cavitation limit.
- A safety margin of at least 0.5 m must be added when selecting the pump to compensate for measuring inaccuracies.
- The NPSH curves reflect average values.
- A safety margin of 0.5 m must be added to the NPSH value of the characteristic curve when selecting a system.

P [kW], [hp]:

- The power input is indicated per stage ($St = 1$) and/or per stage with a smaller impeller ($St = -1$). The pump input power can be calculated accordingly. Calculation: value indicated in the diagram ($St = 1$) \times number of stages + value indicated in the diagram ($St = -1$) \times number of stages with a smaller impeller
 Example 1, Movitec 90/4: $P = (St = 1) \times 4$
 Example 2, Movitec 90/4-1: $P = (St = 1) \times 3 + (St = -1)$
 Example 3, Movitec 90/4-2: $P = (St = 1) \times 2 + (St = -1) \times 2$

Fluid handled

The actual operating conditions must always be checked (concentration, temperature, solids content). Penetration of air into the system must be avoided by all means.

If the fluid handled contains solids such as steel chips or steel chip dust, check the permissible particle concentration with KSB.

Minimum flow rate and maximum flow rate

Minimum flow rate and maximum flow rate Q at a fluid temperature $\leq +20^\circ\text{C}$

Movitec	Q			
	2 poles		4 poles	
	Min. [m ³ /h]	Max. [m ³ /h]	Min. [m ³ /h]	Max. [m ³ /h]
2B	0,2	3,3	-	-
4B	0,4	6,5	-	-
6B	0,6	9,0	-	-
10B	1,1 ¹¹⁾	13,2	0,5	6,6
15B	1,6 ¹¹⁾	22,5	0,8	11,3
25B	2,8	35,0	1,4	17,5
40B	4,0	54,0	2,0	27,0
60B	6,0	76,0	3,0	38,0
90B	8,5	110,0	4,3	53,9
125B	12,2	160,0	-	-
LHS 6	0,8	8,6	-	-

11) For pumps with VdS certification the minimum flow rate Q_{min} is 5 % of the permissible flow rate.

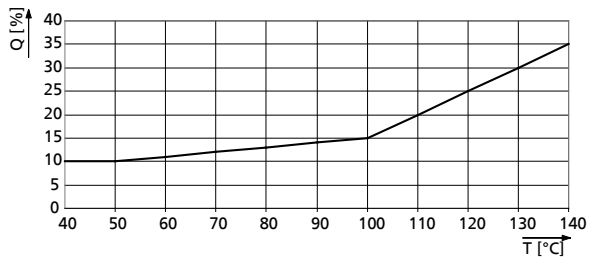

Fig. 3: Minimum flow rate required as a function of fluid temperature at a fluid temperature $> +20$ °C

Overview of product features / selection tables
Table of fluids handled

The data refer to the chemical resistance of the materials. The relevant regulations / standards governing individual pump applications have to be complied with.

If the operating conditions differ from the data given (e.g. mixed products) or if the fluids handled are not included in the table below, please contact KSB.

- **Temperature ranges:**
 - Reference temperature: +20 °C
 - For temperatures <0 °C: contact KSB.
 - For temperatures > +50 °C: check and observe the vapour pressure of the fluid handled.
 - Max. temperature = +120 °C, unless indicated otherwise.
- Max. concentration = 100 % unless indicated otherwise.
- Mechanical seal silicon carbide / carbon (Q1B): not suitable for fluids containing solid substances. This rule also covers particles developing as a result of salt crystallisation at low fluid temperatures.
- Mechanical seal tungsten carbide / tungsten carbide (U3U3): solids content max. 20 ppm (depending on particle size), with the exception of corrosive fluids. Fluids with a higher solids content are not permitted (ppm = 1 mg/kg).
- Caution: High temperatures will increase corrosion (reference temperature = +20 °C).
- Under unfavourable conditions (high temperatures, deposits, long idle periods), chloride contents of more than 300 mg/l may result in localised corrosion.

Selecting the design of pump and mechanical seal depending on the fluid to be handled

Fluid handled			Movitec																		
Substance contained	Max. percentage	T _{max.}	V					VC					VS					LHS			
			[%]	[°C]	13	14	15	16	18	13	14	15	16	18	23	13	14	15	16	18	17
Alum, acid-free	≤ 3	+50	-	X	-	-	-	-	-	-	-	-	-	-	-	X	-	-	-	-	-
Alum, acid-free	≤ 3	+80	-	-	-	-	-	-	-	-	-	-	-	-	-	X	-	-	-	-	-
Alkaline solution, bottle rinsing, max. 2 % sodium hydroxide	≤ 100	+40	-	-	X	-	-	-	-	X	-	-	-	-	-	X	-	-	-	-	-
Alcohol																					
▪ Butanol	≤ 100	+60	X	-	-	-	-	X	-	-	-	-	X	X	-	-	-	-	-	-	-
▪ Ethanol	≤ 100	+60	X	-	-	-	-	X	-	-	-	-	X	X	-	-	-	-	-	-	-
▪ Propanol	≤ 100	+80	X	-	-	-	-	X	-	-	-	-	X	X	-	-	-	-	-	-	-
▪ Spirits (40 % ethanol)	≤ 100	+60	X	-	-	-	-	-	-	-	-	-	-	X	-	-	-	-	-	-	-
Wine (white, red)	≤ 100	+60	X	X	-	-	-	-	-	-	-	-	-	X	X	-	-	-	-	X	X
Tartaric acid	≤ 100	+60	-	-	-	-	-	-	-	-	-	-	-	-	-	-	-	-	-	X	-
Ammonium bicarbonate	≤ 10	+40	X	-	-	-	-	X	-	-	-	-	X	X	-	-	-	-	-	-	-
Aluminium sulphate, acid-free	≤ 5	+50	-	-	-	X	-	-	-	-	-	-	-	-	-	-	-	X	-	-	-
Aluminium sulphate, acid-free	≤ 5	+60	-	-	-	-	-	-	-	-	-	-	-	-	-	-	-	X	-	-	-
Ammonium sulphate	≤ 20	+60	X	-	-	-	-	-	-	-	-	-	-	X	-	-	-	-	-	-	-
Calcium acetate, acid-free	≤ 10	+60	X	-	-	-	-	X	-	-	-	-	X	X	-	-	-	-	-	-	-
Calcium nitrate, acid-free	≤ 10	+60	-	-	-	X	-	-	-	-	-	-	-	-	-	-	-	X	-	-	-
Ferric sulphate (II)	≤ 5	+80	-	-	-	X	-	-	-	-	-	-	-	-	-	-	-	X	-	-	-
Water-oil emulsion (95 %, 5 %), free of solids	≤ 100	+80	-	X	-	-	-	-	X	-	-	-	-	-	-	X	-	-	-	-	-
Ethylene glycol base antifreeze, inhibited, closed system	≤ 20	+110	X ¹²⁾	X	-	X	-	X ¹²⁾	X	-	X	-	X ¹²⁾	X ¹²⁾	X	-	X	-	-	-	-
	≤ 25	+110	X ¹²⁾	X	-	X	-	X ¹²⁾	X	-	X	-	X ¹²⁾	X ¹²⁾	X	-	X	-	-	-	-
	≤ 30	+110	X ¹²⁾	X	-	X	-	X ¹²⁾	X	-	X	-	X ¹²⁾	X ¹²⁾	X	-	X	-	-	-	-
	≤ 35	+110	X ¹²⁾	X	-	X	-	X ¹²⁾	X	-	X	-	X ¹²⁾	X ¹²⁾	X	-	X	-	-	-	-
	≤ 40	+110	X ¹²⁾	X	-	X	-	X ¹²⁾	X	-	X	-	X ¹²⁾	X ¹²⁾	X	-	X	-	-	-	-
	≤ 45	+110	X ¹²⁾	X	-	X	-	X ¹²⁾	X	-	X	-	X ¹²⁾	X ¹²⁾	X	-	X	-	-	-	-
	≤ 50	+110	X ¹²⁾	X	-	X	-	X ¹²⁾	X	-	X	-	X ¹²⁾	X ¹²⁾	X	-	X	-	-	-	-
Ethylene glycol base antifreeze, inhibited, open system	≤ 20	+110	X ¹²⁾	X	-	X	-	-	-	-	-	-	-	X ¹²⁾	X	-	X	-	-	-	-
	≤ 25	+110	X ¹²⁾	X	-	X	-	-	-	-	-	-	-	X ¹²⁾	X	-	X	-	-	-	-

12) ≤ 100 °C

Fluid handled			Movitec																		
Substance contained	Max. percentage	T _{max.}	V					VC						VS					LHS		
			[%]	[°C]	13	14	15	16	18	13	14	15	16	18	23	13	14	15	16	18	17
Ethylene glycol base antifreeze, inhibited, open system	≤ 30	+110	X ¹²⁾	X	-	X	-	-	-	-	-	-	-	-	X ¹²⁾	X	-	X	-	-	-
	≤ 35	+110	X ¹²⁾	X	-	X	-	-	-	-	-	-	-	-	X ¹²⁾	X	-	X	-	-	-
	≤ 40	+110	X ¹²⁾	X	-	X	-	-	-	-	-	-	-	-	X ¹²⁾	X	-	X	-	-	-
	≤ 45	+110	X ¹²⁾	X	-	X	-	-	-	-	-	-	-	-	X ¹²⁾	X	-	X	-	-	-
	≤ 50	+110	X ¹²⁾	X	-	X	-	-	-	-	-	-	-	-	X ¹²⁾	X	-	X	-	-	-
Glycerine	≤ 40	+80	X	X	-	-	-	X	X	-	-	-	X	X	X	X	-	-	-	-	-
Glycols (pure)	≤ 100	+100	-	-	-	-	-	-	-	-	-	-	-	-	-	-	-	-	-	-	-
Diethylene glycol	≤ 100	+100	X	X	-	-	-	X	X	-	-	-	X	X	X	X	-	-	-	-	-
Ethylene glycol	≤ 100	+100	X	X	-	-	-	X	X	-	-	-	X	X	X	X	-	-	-	-	-
Potassium hydroxide	≤ 5	+40	-	-	X	-	-	-	-	X	-	-	-	-	-	-	X	-	-	-	-
Potassium nitrate, acid-free	≤ 5	+30	-	-	X	-	-	-	-	X	-	-	-	-	-	-	X	-	-	-	-
Potassium sulphate, acid-free	≤ 3	+20	-	X	-	-	-	-	X	-	-	-	-	-	-	X	-	-	-	-	-
Copper sulphate	≤ 5	+80	-	-	X	-	-	-	-	-	-	-	-	-	-	-	X	-	-	-	-
Magnesium sulphate	≤ 10	+80	-	X	-	-	-	-	-	-	-	-	-	-	-	X	-	-	-	X	-
Milk	≤ 100	+60	X	X	-	-	-	-	-	-	-	-	-	-	X	X	-	-	-	-	-
Lactic acid	≤ 40	+60	-	-	-	-	-	-	-	-	-	-	-	-	-	-	-	-	-	X	-
Miscella ¹³⁾	≤ 100	+40	-	-	-	-	-	-	-	-	-	-	-	-	-	-	-	-	-	-	-
Sodium carbonate	≤ 6	+60	X	-	-	-	-	X	-	-	-	-	X	X	-	-	-	-	-	-	X
Sodium hydroxide	≤ 5	+60	-	-	X	-	-	-	-	X	-	-	-	-	-	-	X	-	-	-	-
Sodium nitrate, acid-free	≤ 10	+30	X	-	-	-	-	X	-	-	-	-	X	X	-	-	-	-	-	-	X
Sodium nitrate, acid-free	≤ 10	+60	X	-	-	-	-	X	-	-	-	-	-	-	-	-	-	-	-	-	X
Sodium sulphate, acid-free	≤ 5	+60	X	-	-	-	-	-	-	-	-	-	-	-	X	-	-	-	-	-	X
Oil																					
▪ Peanut oil	≤ 100	+90	-	X	-	-	-	-	X	-	-	-	-	-	-	X	-	-	-	-	-
▪ Peanut oil	≤ 100	+100	-	-	-	-	-	-	-	-	-	-	-	-	-	-	-	-	-	X	-
▪ Hydraulic oil ¹³⁾	≤ 100	+80	-	-	-	-	-	-	-	-	-	-	-	-	-	-	-	-	-	X	-
▪ Linseed oil, ≤ 3 % H ₂ SO ₄	≤ 100	+20	-	X	-	-	-	-	-	-	-	-	-	-	-	X	-	-	-	-	-
▪ Linseed oil, ≤ 3 % H ₂ SO ₄	≤ 100	+60	-	-	-	-	-	-	-	-	-	-	-	-	-	X	-	-	-	-	-
▪ Linseed oil	≤ 100	+60	-	X	-	-	-	-	X	-	-	-	-	-	-	X	-	-	-	X	-
▪ Corn oil	≤ 100	+100	-	X	-	-	-	-	X	-	-	-	-	-	-	X	-	-	-	X	-
▪ Mineral oil ¹³⁾	≤ 100	+80	-	-	-	-	-	-	-	-	-	-	-	-	-	-	-	-	-	X	-
▪ Vegetable oil ¹³⁾	≤ 100	+100	-	-	-	-	-	-	-	-	-	-	-	-	-	-	-	-	-	X	-
▪ Rapeseed oil	≤ 100	+100	-	X	-	-	-	-	X	-	-	-	-	-	-	X	-	-	-	X	-
▪ Salad oil	≤ 100	+100	-	-	-	-	-	-	-	-	-	-	-	-	-	-	-	-	-	X	-
▪ Lubricating oil ¹³⁾	≤ 100	+100	-	-	-	-	-	-	-	-	-	-	-	-	-	-	-	-	-	X	-
▪ Silicone oil ¹³⁾	≤ 100	+60	-	-	-	-	-	-	-	-	-	-	-	-	-	-	-	-	-	X	-
▪ Soybean oil	≤ 100	+100	-	X	-	-	-	-	X	-	-	-	-	-	-	X	-	-	-	X	-
▪ Turbine oil (no SDF oils) ¹³⁾	≤ 100	+100	-	-	-	-	-	-	-	-	-	-	-	-	-	-	-	-	-	X	-
▪ Oil-water mixtures	≤ 100	+100	-	-	-	-	-	-	-	-	-	-	-	-	-	-	-	-	-	X	-
Paraffin ¹³⁾	≤ 100	+100	-	-	-	-	-	-	-	-	-	-	-	-	-	-	-	-	-	X	-
Kerosene	≤ 100	+80	-	X	-	-	-	-	-	-	-	-	-	-	-	X	-	-	-	X	-
Polyethylene glycol ¹³⁾	≤ 100	+80	-	-	-	-	-	-	-	-	-	-	-	-	-	-	-	-	-	X	X
Polyglycol ¹³⁾	≤ 100	+80	-	-	-	-	-	-	-	-	-	-	-	-	-	-	-	-	-	X	-
Crude oil ¹³⁾	≤ 100	+80	-	-	-	-	-	-	-	-	-	-	-	-	-	-	-	-	-	X	-
Crude oil condensate ¹³⁾	≤ 100	+80	-	-	-	-	-	-	-	-	-	-	-	-	-	-	-	-	-	X	-

13) Fluid details are required in this case.

Fluid handled			Movitec																				
Substance contained	Max. percentage	T _{max.}	V					VC					VS					LHS					
			[%]	[°C]	13	14	15	16	18	13	14	15	16	18	23	13	14	15	16	18	17	19	
Juice (fruit and sugar juice)	≤ 100	+60	-	X	-	-	-	-	-	-	-	-	-	-	-	-	X	-	-	-	-	X	-
Acid																							
▪ Acetic acid	≤ 10	+60	X	-	-	-	-	-	-	-	-	-	-	-	-	-	X	-	-	-	-	-	-
▪ Acetic acid	≤ 5	+60	X	-	-	-	-	-	-	-	-	-	-	-	-	-	X	-	-	-	-	-	-
▪ Tannic acid	≤ 20	+80	-	X	-	-	-	-	-	-	-	-	-	-	-	-	X	-	-	-	-	-	-
▪ Maleic acid	≤ 10	+60	-	X	-	-	-	-	-	-	-	-	-	-	-	-	X	-	-	-	-	-	-
▪ Lactic acid	≤ 5	+60	-	X	-	-	-	-	-	-	-	-	-	-	-	-	X	-	-	-	-	-	-
▪ Lactic acid	≤ 40	+60	-	X	-	-	-	-	-	-	-	-	-	-	-	-	X	-	-	-	-	-	-
▪ Phosphoric acid	≤ 5	+20	-	X	-	-	-	-	-	-	-	-	-	-	-	-	X	-	-	-	-	-	-
▪ Sulphuric acid	≤ 5	+20	-	-	-	-	-	-	-	-	-	-	-	-	-	-	-	-	X	-	-	-	-
▪ Tartaric acid	≤ 8	+40	-	-	-	-	-	-	-	-	-	-	-	-	-	-	X	-	-	-	-	-	-
▪ Citric acid	≤ 25	+30	-	X	-	-	-	-	-	-	-	-	-	-	-	-	X	-	-	-	-	-	-
▪ Citric acid	≤ 10	+30	-	X	-	-	-	-	-	-	-	-	-	-	-	-	X	-	-	-	-	-	-
Fuel																							
▪ Diesel oil	≤ 100	+80	-	X	-	-	-	-	-	-	-	-	-	-	-	-	X	-	-	-	-	-	-
▪ Fuel oil	≤ 100	+80	-	X	-	-	-	-	-	-	-	-	-	-	-	-	X	-	-	-	-	-	-
▪ Jet fuel	≤ 100	+80	-	X	-	-	-	-	-	-	-	-	-	-	-	-	X	-	-	-	-	-	-
Trisodium phosphate	≤ 4	+80	-	-	X	-	-	-	X	-	-	-	-	-	-	-	-	X	-	-	-	-	-
Water																							
▪ Deionised water (fully desalinated)	≤ 100	+140	X	-	-	-	X ¹⁴⁾	-	-	-	-	-	-	-	-	-	X	-	-	-	X ¹⁴⁾	-	X
▪ Distilled water	≤ 100	+140	-	-	-	-	-	-	-	-	-	-	-	-	-	-	-	-	-	-	-	-	X ¹⁵⁾
▪ Dealkalised water	≤ 100	+120	-	-	X	-	-	-	-	-	-	-	-	-	-	-	X	-	-	-	-	-	-
▪ Decarbonised water	≤ 100	+120	-	-	X	-	-	-	-	-	-	-	-	-	-	-	X	-	-	-	-	-	-
▪ Swimming pool water (no brine)	≤ 100	+100	-	-	-	-	-	-	-	-	-	-	-	-	-	-	-	-	-	-	-	X	-
▪ Permeate (osmosis)	≤ 100	+140	X	-	-	-	X ¹⁴⁾	-	-	-	-	-	-	-	-	-	X	-	-	-	X ¹⁴⁾	-	-
▪ Partly desalinated water	≤ 100	+120	-	-	X	-	-	-	-	-	-	-	-	-	-	-	X	-	-	-	-	-	-
▪ Fire-fighting water	≤ 100	+60	-	-	X	-	X	-	X	-	-	X	-	-	-	-	X	-	X	-	X	-	-
▪ Heating water in accordance with VDI 2035	≤ 100	+100	X	-	-	-	X	X	-	-	-	X	X	X	-	-	-	-	-	X	-	X ¹⁵⁾	-
▪ Hot water treated in accordance with VdTÜV 1466	≤ 100	+140	X ¹²⁾	-	-	-	X ¹⁴⁾	X ¹²⁾	-	-	-	X ¹⁴⁾	X ¹²⁾	X ¹²⁾	-	-	-	-	-	X ¹⁴⁾	-	X ¹⁵⁾	-
▪ Boiler feed water to VdTÜV 1466	≤ 100	+140	X ¹²⁾	-	-	-	X ¹⁴⁾	X ¹²⁾	-	-	-	X ¹⁴⁾	X ¹²⁾	X ¹²⁾	-	-	-	-	-	X ¹⁴⁾	-	X ¹⁵⁾	-
▪ Condensate treated in acc. with VdTÜV 1466	≤ 100	+140	X ¹²⁾	-	-	-	X ¹⁴⁾	X ¹²⁾	-	-	-	X ¹⁴⁾	X ¹²⁾	X ¹²⁾	-	-	-	-	-	X ¹⁴⁾	-	X ¹⁵⁾	-
▪ Vapour condensate (brewery)	≤ 100	+140	X ¹²⁾	-	-	-	X ¹⁴⁾	X ¹²⁾	-	-	-	X ¹⁴⁾	X ¹²⁾	X ¹²⁾	-	-	-	-	-	X ¹⁴⁾	-	-	-
▪ Cooling water	≤ 100	+100	-	-	-	X	-	-	-	-	X	-	-	-	-	-	-	-	X	-	-	-	-
▪ Tap water	≤ 100	+60	X	-	-	-	-	X	-	-	-	-	-	-	-	-	X	-	-	-	-	-	-
▪ Brewing water	≤ 100	+60	X	-	-	-	-	X	-	-	-	-	-	-	-	-	X	-	-	-	-	-	-
▪ Ice water (brewery)	≤ 100	+60	X	-	-	-	-	X	-	-	-	-	-	-	-	-	X	-	-	-	-	-	-

14) ≤ 120 °C, depending on the pressure classes
15) ≤ 120 °C

Fluid handled			Movitec																			
Substance contained	Max. percentage	T _{max.}	V					VC						VS					LHS			
			[%]	[°C]	13	14	15	16	18	13	14	15	16	18	23	13	14	15	16	18	17	19
▪ Drinking water / tap water	≤ 100	+60	X	-	-	-	-	X	-	-	-	-	-	-	X	-	-	-	-	-	X	
▪ Hot water (brewery)	≤ 100	+60	X	-	-	-	-	X	-	-	-	-	-	-	X	-	-	-	-	-	-	
▪ Clean water	≤ 100	+60	X	X	X	X	X	X	X	X	X	X	X	X	X	X	X	X	X	X	-	-
▪ Brackish water	≤ 100	+15	-	-	-	-	-	-	-	-	-	-	-	-	-	-	-	X	-	-	-	
▪ Seawater	≤ 100	+15	-	-	-	-	-	-	-	-	-	-	-	-	-	-	-	X	-	-	-	
▪ Raw water	≤ 100	+60	-	-	X	-	-	-	-	X	-	-	-	-	-	-	X	-	-	-	-	
▪ Grey water, slightly contaminated water	≤ 100	+60	-	-	X	-	-	-	-	X	-	-	-	-	-	-	X	-	-	-	-	
▪ River water	≤ 100	+60	-	-	X	-	-	-	-	X	-	-	-	-	-	-	X	-	-	-	-	
▪ Lake water	≤ 100	+60	-	-	X	-	-	-	-	X	-	-	-	-	-	-	X	-	-	-	-	
▪ Dam water	≤ 100	+60	-	-	X	-	-	-	-	X	-	-	-	-	-	-	X	-	-	-	-	
▪ Surface water	≤ 100	+60	-	-	X	-	-	-	-	X	-	-	-	-	-	-	X	-	-	-	-	
▪ Fresh water	≤ 100	+60	-	X	-	-	-	-	X	-	-	-	-	-	-	X	-	-	-	-	-	
▪ Barrier water	≤ 100	+70	-	-	-	X	-	-	-	-	X	-	-	-	-	-	-	X	-	-	-	
▪ Rinsing water	≤ 100	+70	-	-	-	X	-	-	-	-	X	-	-	-	-	-	-	X	-	-	-	
▪ Rainwater, with strainer	≥ 20	+60	-	-	-	X	-	-	-	-	X	-	-	-	-	-	-	X	-	-	-	
▪ Water-glycol mixture	≤ 100	+100	-	-	-	-	-	-	-	-	-	-	-	-	-	-	-	-	-	-	X	

Shaft seal

Available mechanical seals

Mechanical seal							T		p [bar]	Certification
Code	Type	Material		Design			Min.	Max.		
		Mechanical seal	Shaft seal ring	C	E	F	[°C]	[°C]		
11	M12G-G60	B Q1 E G G	Ca/SiC/EPDM	X	X	X	-20	+100	10	-
12	M12G-G60	B Q1 V G G	Ca/SiC/FPM	X	X	X	-20	+120	10	-
13	RMG12-G606	Q1 B E G G	SiC/Ca/EPDM	X	X	X	-20	+100	25	WRAS
14	RMG12-G606	Q1 B V G G	SiC/Ca/FPM	X	X	X	-20	+120	25	-
15	RMG12-G606	U3 U3 X4 G G	TuC/TuC/HNBR	X	X	X	-20	+120 ¹⁶⁾	25	-
16	RMG12-G606	U3 U3 V G G	TuC/TuC/FPM	X	X	X	-20	+120 ¹⁶⁾	25	-
17	M37GN2/16-00-R	U3 B V G G	TuC/Ca/FPM ¹⁷⁾	-	-	X	-20	+120	40	-
18	RMG12-G606	U3 B E G G	TuC/Ca/EPDM	X	X	X	-20	+120 ¹⁶⁾	25	-
19	M37GN2/16-00-R	U3 B E G G	TuC/Ca/EPDM	-	-	X	-20	+120	40	-
20	H7N	Q1 A E G G	SiC/Ca/EPDM	X	-	-	-20	+120 ¹⁸⁾	40	-
21	H7N	Q1 A V G G	SiC/Ca/FPM	X	-	-	-20	+120 ¹⁸⁾	40	-
22	H7N	Q1 A X4 G G	SiC/Ca/HNBR	X	-	-	-20	+120 ¹⁸⁾	40	-
23	RMG12-G606	Q1 B E G G	SiC/Ca/EPDM	X	X	X	-20	+100	25	-
24	MG12-G60	Q1 Q1 V G G	SiC1/SiC1/FPM	X	X	X	-20	+120	10	-
28	MG12-G60	Q1 Q1 X4 G G	SiC1/SiC1/HNBR	X	X	X	-20	+120	10	-
29	MG12-G60	Q1 Q1 E G G	SiC1/SiC1/EPDM	X	X	X	-20	+100	10	-
35	RMG12-G6	eCarb-B eSic-Q7 E G G	eCa/eSiC/EPDM	X	-	-	-20	+120	25	WRAS
36	MG12-G6	eCarb-B eSic-Q7 V G G	eCa/eSiC/FPM	X	-	-	-20	+120	25	-
37	RMG12-G606	U3 A V G G	TuC/Ca/FPM	X	-	-	-20	+120 ¹⁶⁾	25	-

16) Temperatures up to 140 °C if the pressure does not exceed 16 bar

17) For Movitec LHS6 only

18) Temperatures up to 140 °C if the pressure does not exceed 25 bar

Key to mechanical seal materials

Description	Code to EN 12756	Seal face materials / secondary seals
Primary ring	B	Hard carbon, resin-impregnated
	U3	Tungsten carbide (CrNiMo binder)
	Q1	Silicon carbide (sintered without pressure)
	eCarb-B	Carbon graphite, resin-impregnated
Mating ring	A	Carbon graphite, antimony-impregnated
	B	Hard carbon, resin-impregnated
	U3	Tungsten carbide (CrNiMo binder)
	Q1	Silicon carbide (sintered without pressure)
	eSic-Q7	Silicon carbide
Elastomer	E	EPDM (ethylene propylene rubber)
	V	FPM (fluoroelastomer)
	X4	HNBR
Spring	G	CrNiMo steel
Other metal parts	G	CrNiMo steel

Pressure limits and temperature limits

Movitec A, B

Movitec A

Pressure limits and temperature limits

Movitec	p	T
	[bar]	[°C]
LHS6	40	120

Movitec B

The pump's pressure limits and temperature limits are indicated on the name plate.

Technical data
Motors

- Efficiency class IE3 to IEC 60034-30 (for three-phase motors ≥ 0.75 kW)

Technical data of the motors

P_N	U_N	I_A	I_A/I_N	$\cos \varphi$	Tolerance U_N	n	η	L_p	Cable gland	Maximum frequency of starts
[kW]	[V]	[A]			[%]	rpm	[%]	[dB]		[h ⁻¹]
0,37	1 × 230	2,6	3,7	0,92	+/-10	2750	67,00	58	1 × M18 × 1,5	20
0,55	1 × 230	3,69	3,9	0,92	+/-10	2760	70,00	56	1 × M18 × 1,5	20
0,75	1 × 230	5	3,9	0,92	+/-10	2780	70,00	56	1 × M20 × 1,5	20
1,1	1 × 230	6,68	4,3	0,95	+/-10	2790	75,00	58	1 × M20 × 1,5	20
1,5	1 × 230	8,99	4,8	0,95	+/-10	2800	76,00	58	1 × M20 × 1,5	20
2,2	1 × 230	13,04	4,8	0,95	+/-10	2800	77,00	58	1 × M20 × 1,5	20
0,37	230/400	1,64/0,94	4,6	0,78	+/-10	2750	74,20	58	1 × M20 × 1,5	20
0,55	230/400	2,31/1,33	5,2	0,75	+/-10	2790	77,60	58	1 × M20 × 1,5	20
0,75	230/400	2,92/1,68	6,8	0,8	+/-10	2855	80,50	60	2 × M20 × 1,5	25
1,1	230/400	4,17/2,4	7	0,8	+/-10	2855	82,70	60	2 × M25 × 1,5	25
1,5	230/400	5,08/2,92	7,7	0,88	+/-10	2900	84,20	63	2 × M25 × 1,5	25
2,2	230/400	7,22/4,15	7,7	0,89	+/-10	2900	86,00	63	2 × M25 × 1,5	25
3	230/400	9,71/5,59	8,8	0,89	+/-10	2910	87,10	63	2 × M25 × 1,5	20
3	400/690	5,59/3,24	8,8	0,89	+/-10	2910	87,10	63	2 × M25 × 1,5	20
4	230/400	13,0/7,45	8,5	0,88	+/-10	2910	88,10	63	2 × M25 × 1,5	20
4	400/690	7,45/4,32	8,5	0,88	+/-10	2910	88,10	63	2 × M25 × 1,5	20
5,5	230/400	17,4/10,0	8,8	0,89	+/-10	2925	89,20	68	2 × M32 × 1,5	20
5,5	400/690	10,0/5,80	8,8	0,89	+/-10	2925	89,20	68	2 × M32 × 1,5	20
7,5	230/400	23,2/13,4	8,8	0,9	+/-10	2925	89,80	68	2 × M32 × 1,5	20
7,5	400/690	13,4/7,74	8,8	0,9	+/-10	2925	89,80	68	2 × M32 × 1,5	20
11	230/400	33,6/19,3	8	0,9	+/-10	2940	91,20	68	2 × M32 × 1,5	15
11	400/690	19,3/11,2	8	0,9	+/-10	2940	91,20	68	2 × M32 × 1,5	15
15	230/400	45,5/26,2	8	0,9	+/-10	2940	91,90	68	2 × M32 × 1,5	15
15	400/690	26,2/15,2	8	0,9	+/-10	2940	91,90	68	2 × M32 × 1,5	15
18,5	230/400	55,2/31,8	8	0,91	+/-10	2945	92,40	68	2 × M32 × 1,5	15
18,5	400/690	31,8/18,4	8	0,91	+/-10	2945	92,40	68	2 × M32 × 1,5	15
22	230/400	65,5/37,6	8,5	0,91	+/-10	2955	92,70	70	2 × M32 × 1,5	15
22	400/690	37,6/21,8	8,5	0,91	+/-10	2955	92,70	70	2 × M32 × 1,5	15
30	230/400	89,7/51,6	8,5	0,9	+/-10	2965	93,30	73	2 × M32 × 1,5	15
30	400/690	51,6/29,9	8,5	0,9	+/-10	2965	93,30	73	2 × M50 × 1,5	15
37	230/400	110/63,3	8,5	0,9	+/-10	2965	93,70	73	2 × M50 × 1,5	15
37	400/690	63,3/36,7	8,5	0,9	+/-10	2965	93,70	73	2 × M50 × 1,5	15
45	230/400	134/76,8	8,5	0,9	+/-10	2970	94,00	75	2 × M50 × 1,5	15
45	400/690	76,8/44,5	8,5	0,9	+/-10	2970	94,00	75	2 × M50 × 1,5	15
0,55	230/400	2,34/1,34	5,3	0,73	+/-10	1425	80,70	57	1 × M20 × 1,5	20
0,75	230/400	3,13/1,8	6,5	0,73	+/-10	1425	82,50	57	1 × M20 × 1,5	20
1,1	230/400	4,21/2,42	6,5	0,78	+/-10	1440	84,40	58	1 × M20 × 1,5	20
1,5	230/400	5,59/3,21	7	0,79	+/-10	1440	85,30	58	1 × M25 × 1,5	20
2,2	230/400	7,86/4,52	7,5	0,81	+/-10	1445	86,70	59	2 × M25 × 1,5	20
3	230/400	10,6/6,10	7,5	0,81	+/-10	1445	87,70	59	2 × M25 × 1,5	20
3	400/690	6,10/3,53	7,5	0,81	+/-10	1445	87,70	59	2 × M25 × 1,5	20
4	230/400	14,0/8,05	8,5	0,81	+/-10	1450	88,50	60	2 × M25 × 1,5	20
4	400/690	8,05/4,66	8,5	0,81	+/-10	1450	88,60	60	2 × M25 × 1,5	20
5,5	230/400	19,0/10,9	8,5	0,81	+/-10	1460	89,90	60	2 × M32 × 1,5	20
5,5	400/690	10,9/6,34	8,5	0,81	+/-10	1460	89,60	60	2 × M32 × 1,5	20
7,5	230/400	25,4/14,6	8,5	0,82	+/-10	1460	90,40	60	2 × M32 × 1,5	20
7,5	400/690	14,6/8,47	8,5	0,82	+/-10	1460	90,40	60	2 × M32 × 1,5	20

- 19) The stainless steel baseplate (see illustration) is available as an option.
 20) For Movitec V
 21) For Movitec VS

Types of connection

Overview of available connection types

Description	Movitec							
	V/VS	VF	VSF ¹⁹⁾	VCF	LHS	VE/VME ¹⁹⁾	VV/VMV/VSV	VT/ VST/VMT ¹⁹⁾
Connection type	Oval flange	Round flange				External thread	Victaulic coupling	Tri-clamp coupling
Standard	ISO 228-1	EN 1092-1/EN 1092-2 ASME B 16.1 JIS			EN1092-2	ISO 228-1	-	DIN 32676
Material	1.4308 ²⁰⁾ / 1.4408 ²¹⁾	EN-GJS-400-15	1.4308	EN-GJL-250	1.4408	EN-GJS-400-15	1.4408	1.4408
Max. pressure class	PN 16	PN 40			PN 40	PN 16	PN 40	PN 40

Terminal box positions

Top view of terminal box positions

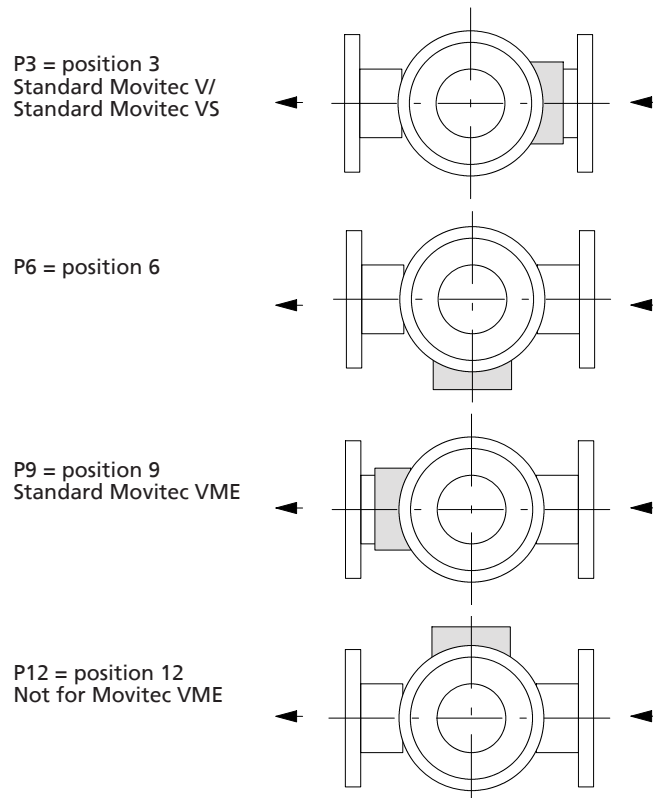

Selection Charts

Movitec, n = 2900 rpm

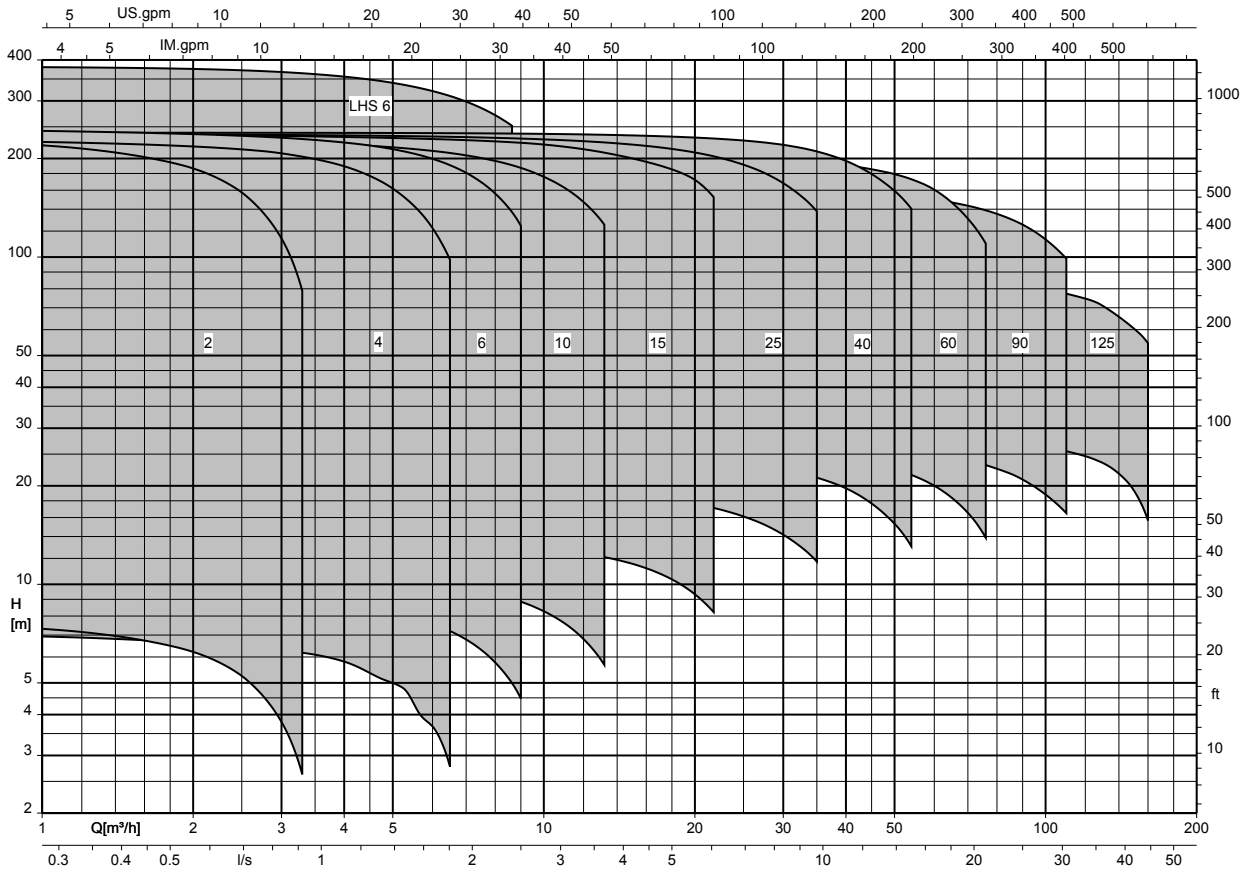

Movitec, n = 1450 rpm

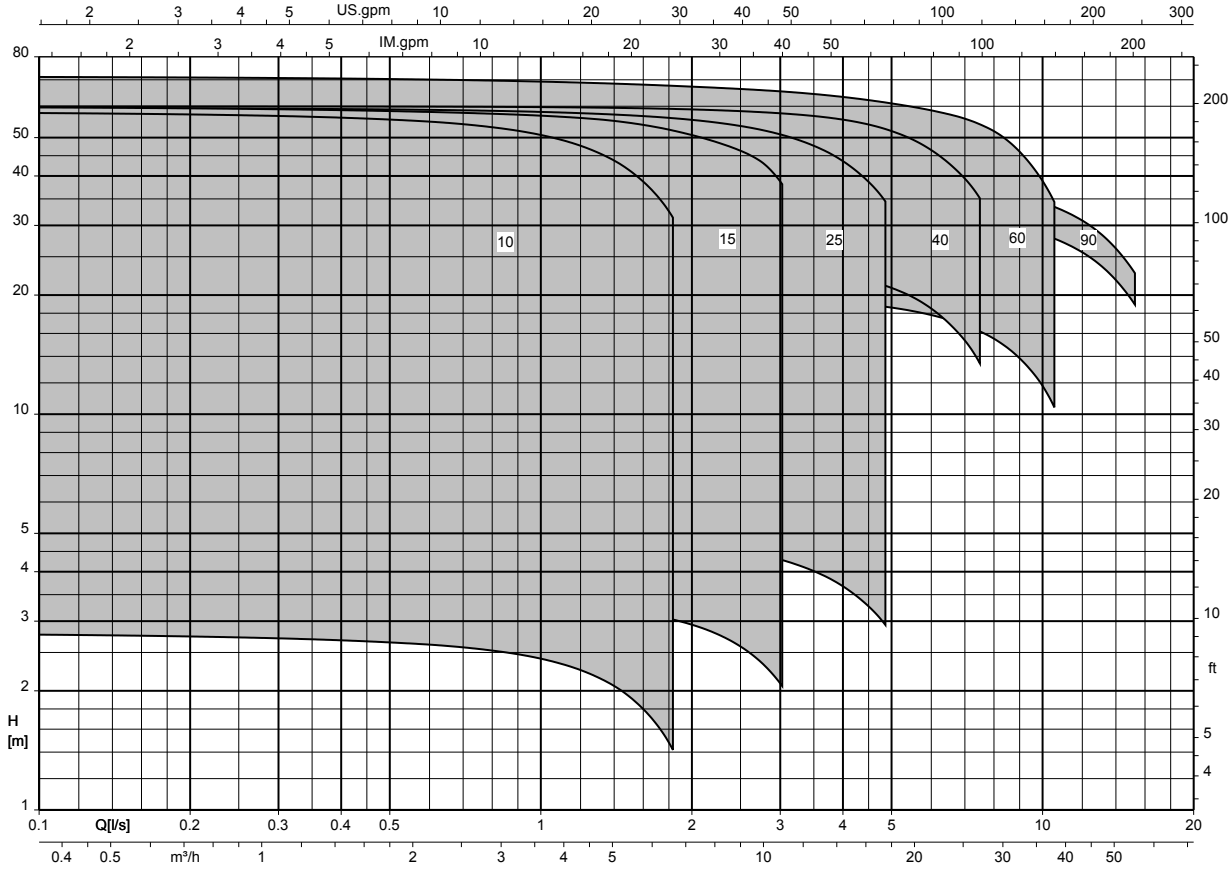

Characteristic curves

The characteristic curves are based on the following principles:

- Tolerances to ISO 9906:2012 Grade 3B

The characteristic curves were measured under the following conditions:

- Motor used:
 - Standardised KSB motor with integrated frequency inverter
- Fluid properties:
 - Deaerated water
 - Fluid temperature: +20 °C
 - Density: 1.0 kg/dm³
 - Kinematic viscosity: 1 mm²/s

n = 2900 rpm

Movitec, 2B, n = 2900 rpm

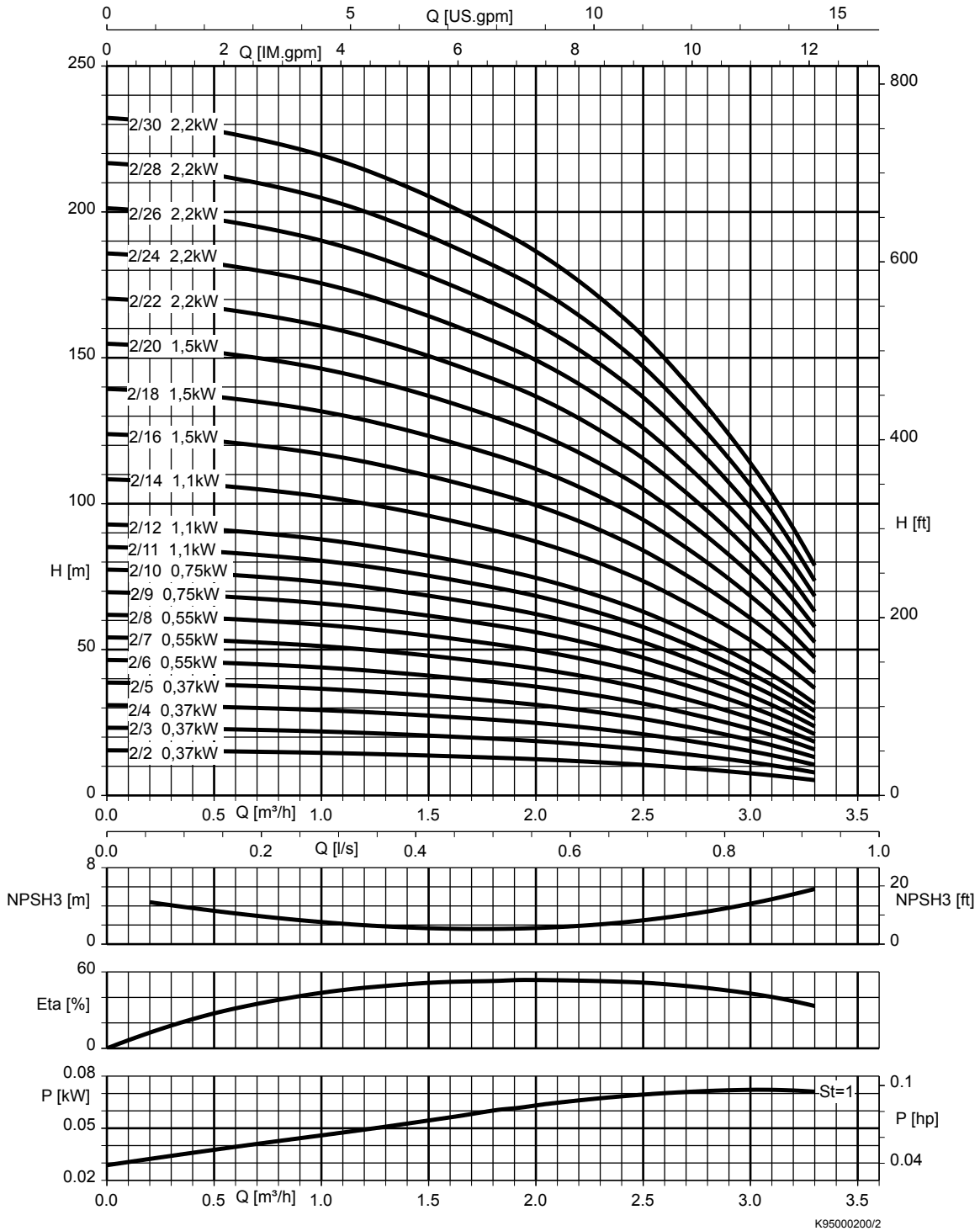

St = 1 | P per stage

Movitec, 2LB, n = 2900 rpm

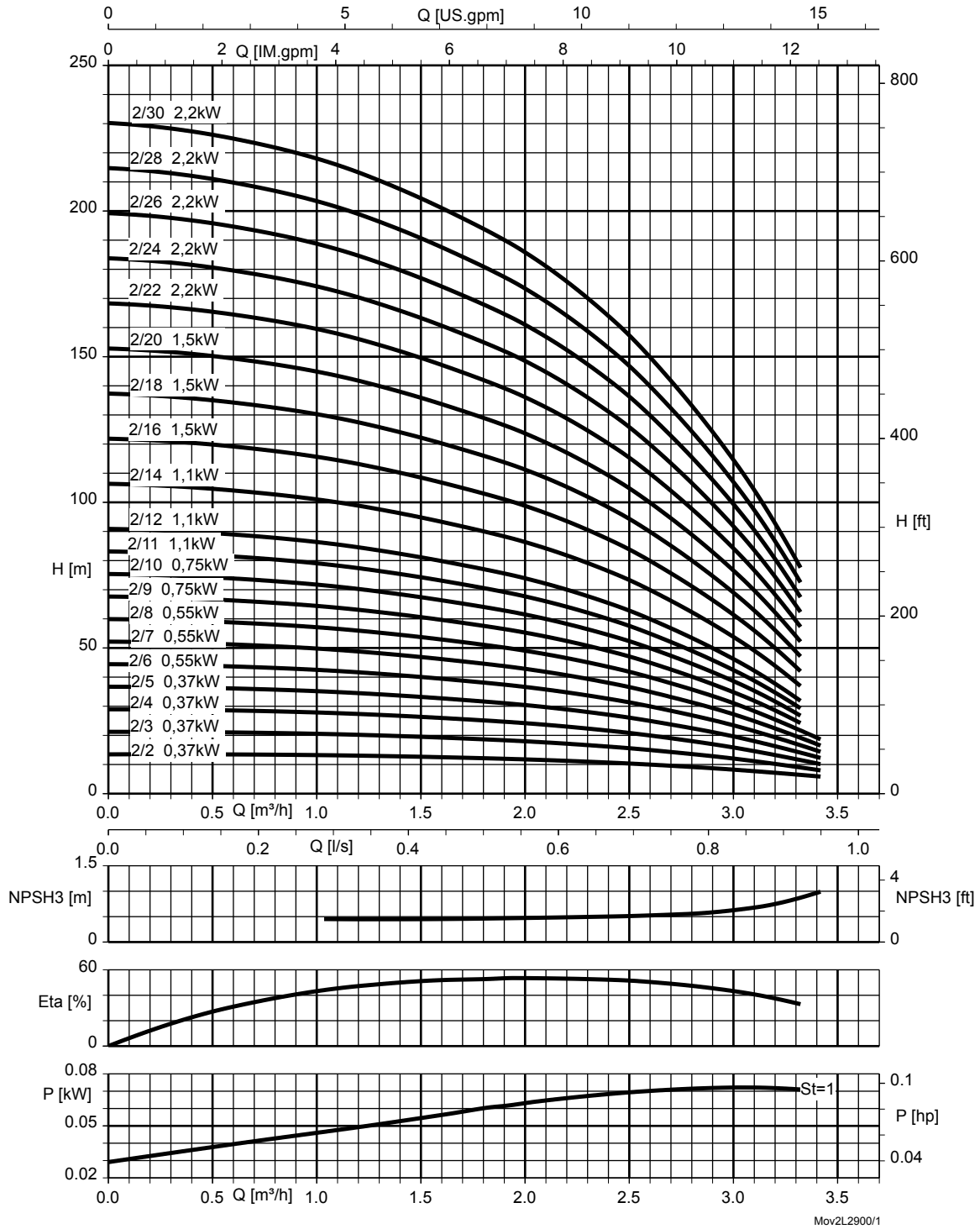

St = 1 | P per stage

Movitec, 4B, n = 2900 rpm

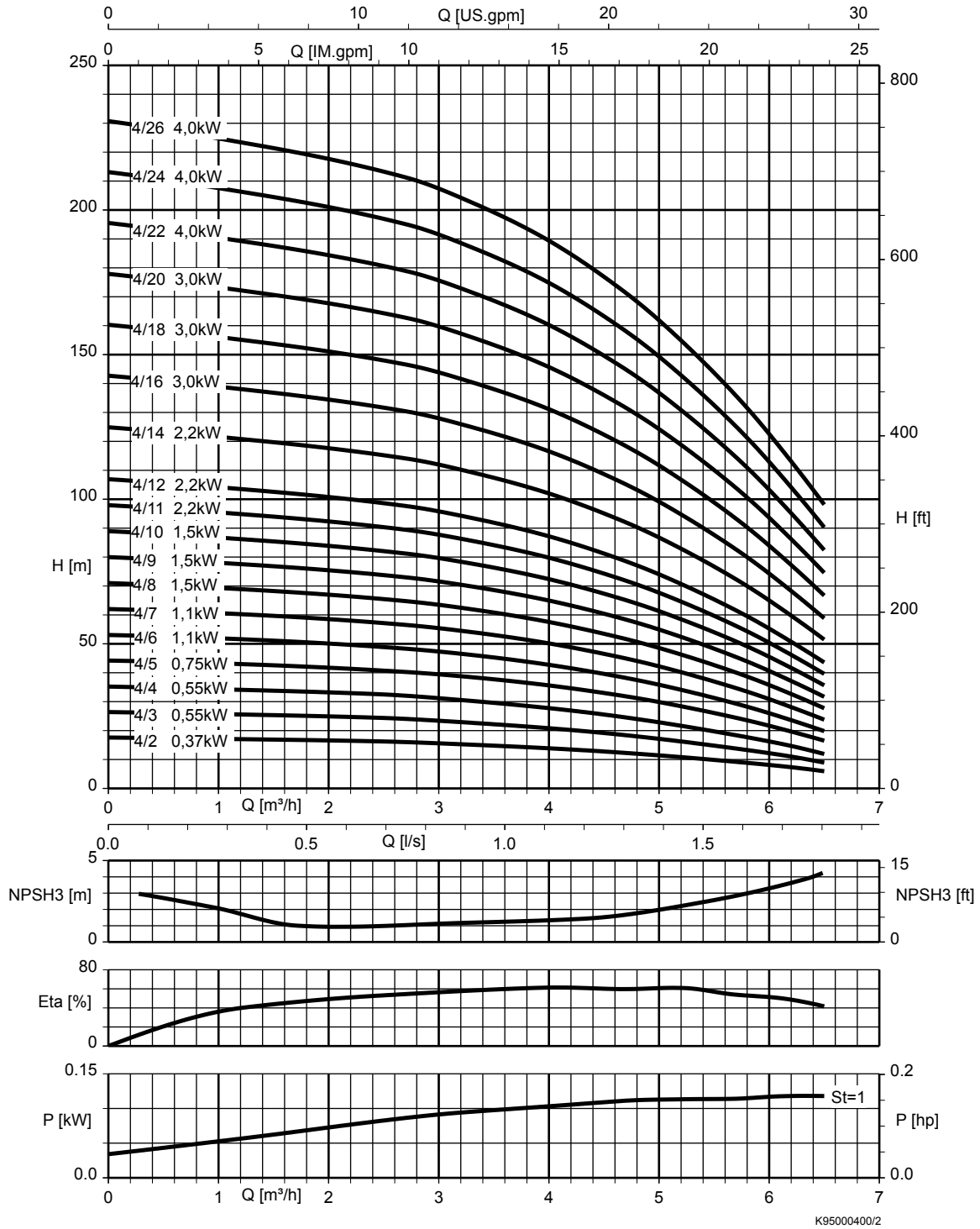

St = 1 | P per stage

Movitec, 4LB, n = 2900 rpm

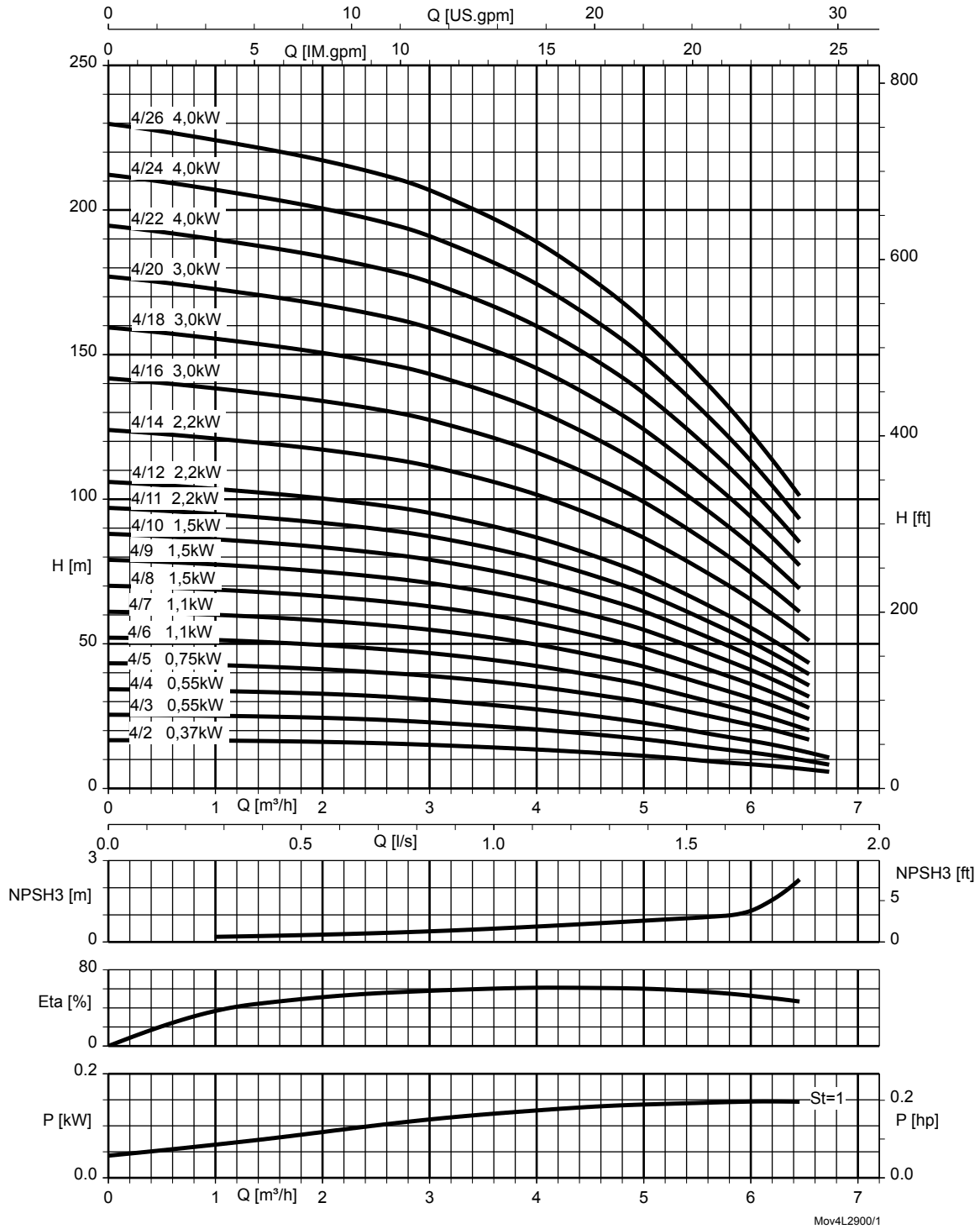

St = 1 | P per stage

Movitec, 6B, n = 2900 rpm

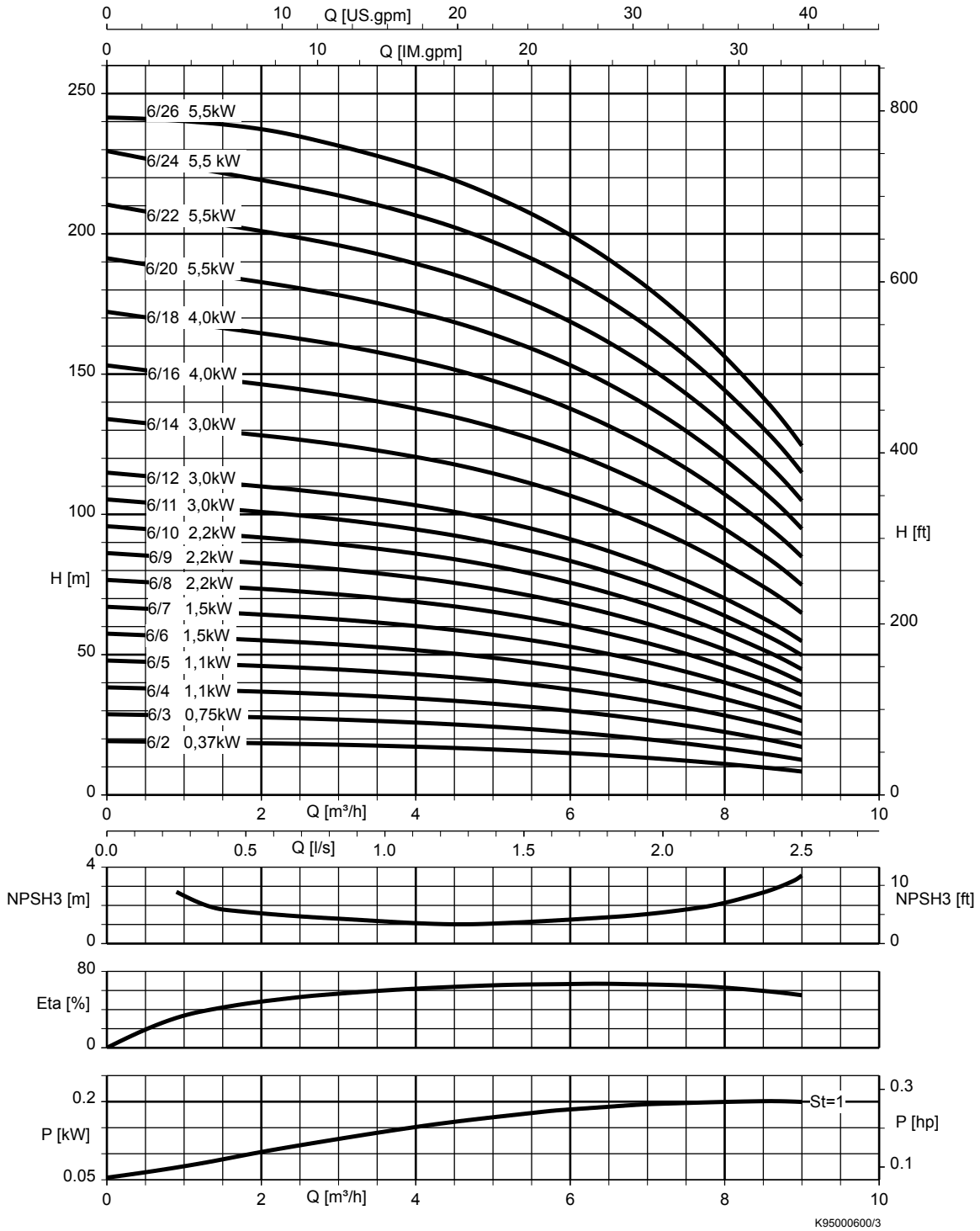

St = 1 | P per stage

Movitec, 6LB, n = 2900 rpm

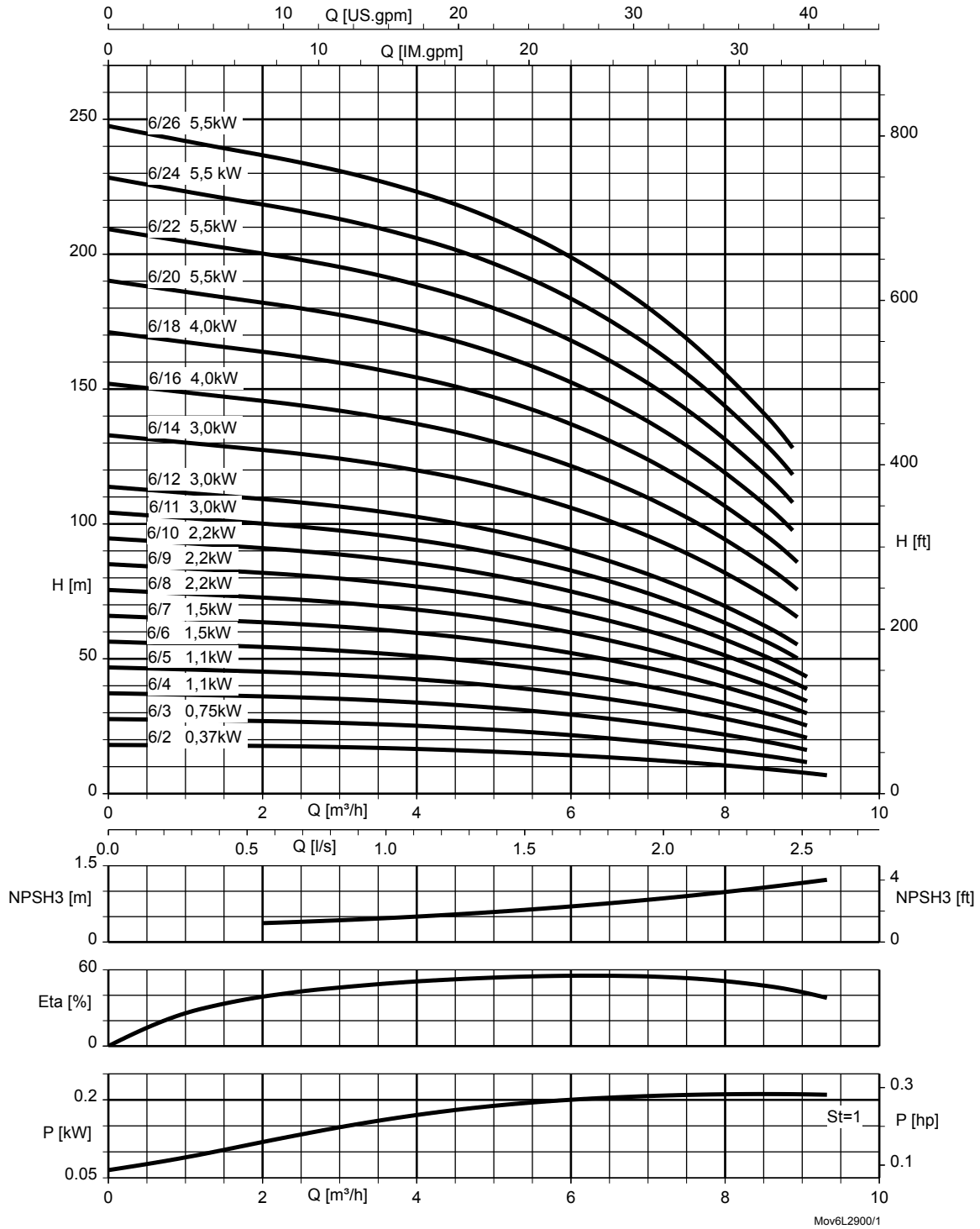

St = 1 | P per stage

Movitec, 10B, n = 2900 rpm

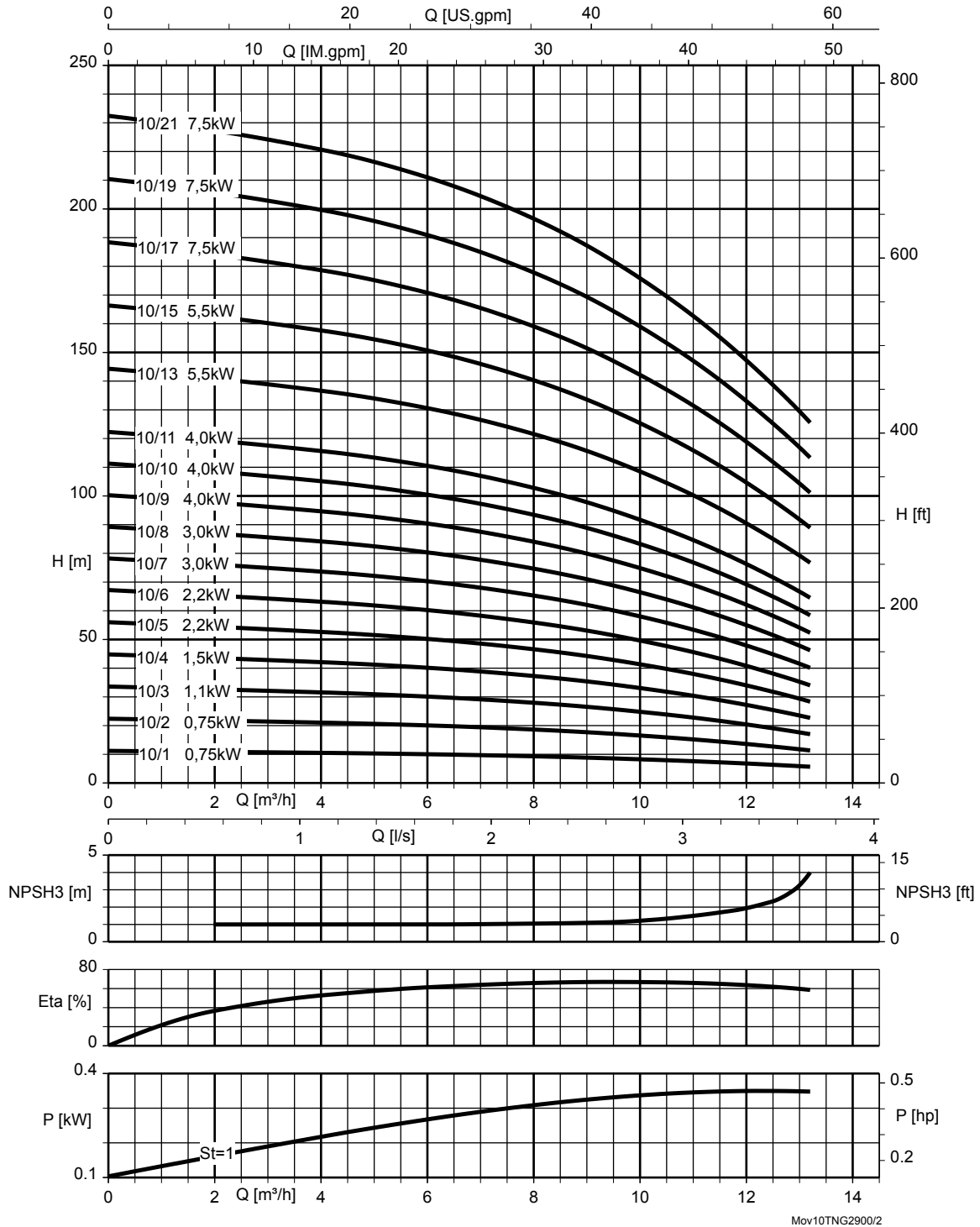

St = 1 | P per stage

Movitec, 10LB, n = 2900 rpm

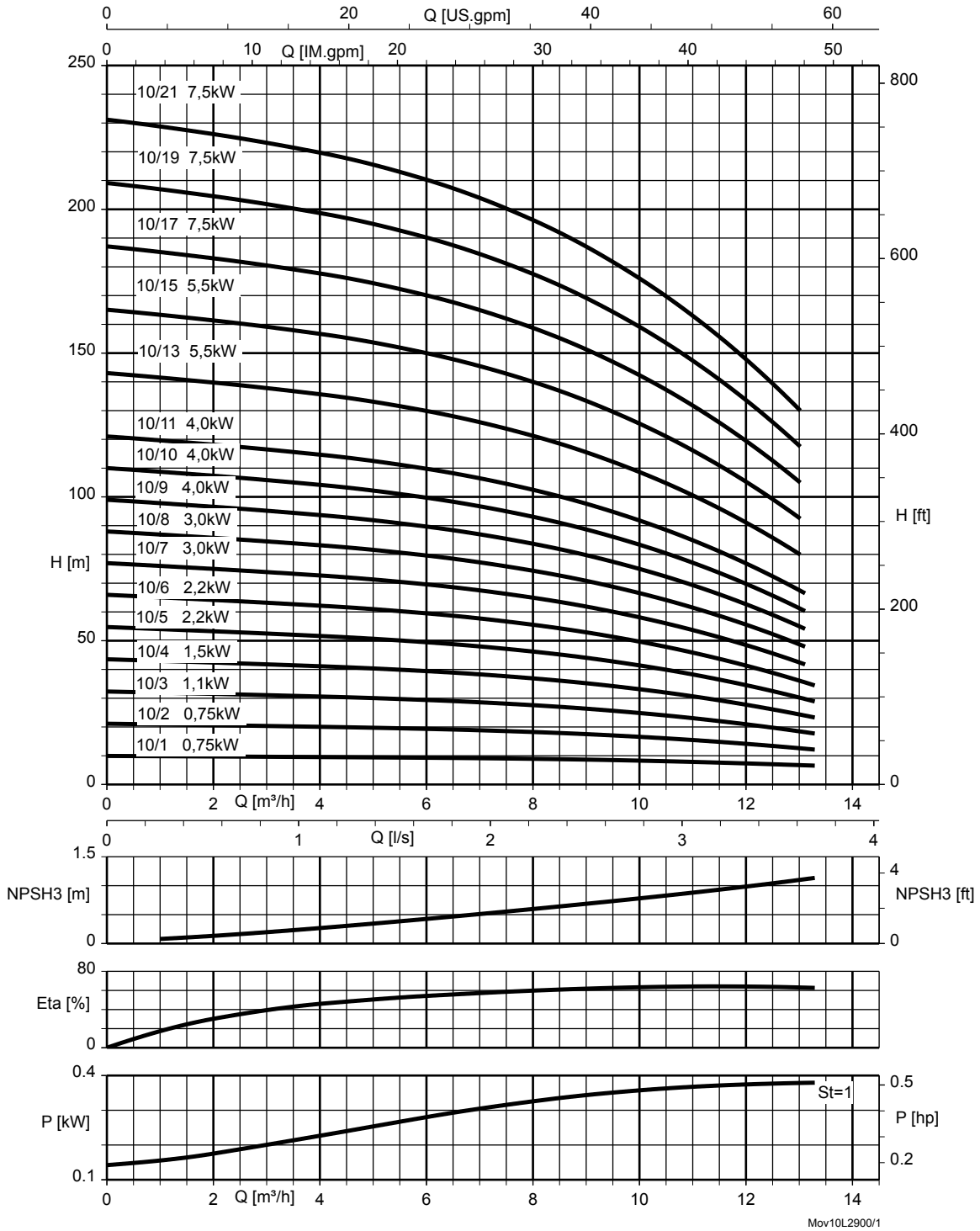

St = 1 | P per stage

Movitec, 15B, n = 2900 rpm

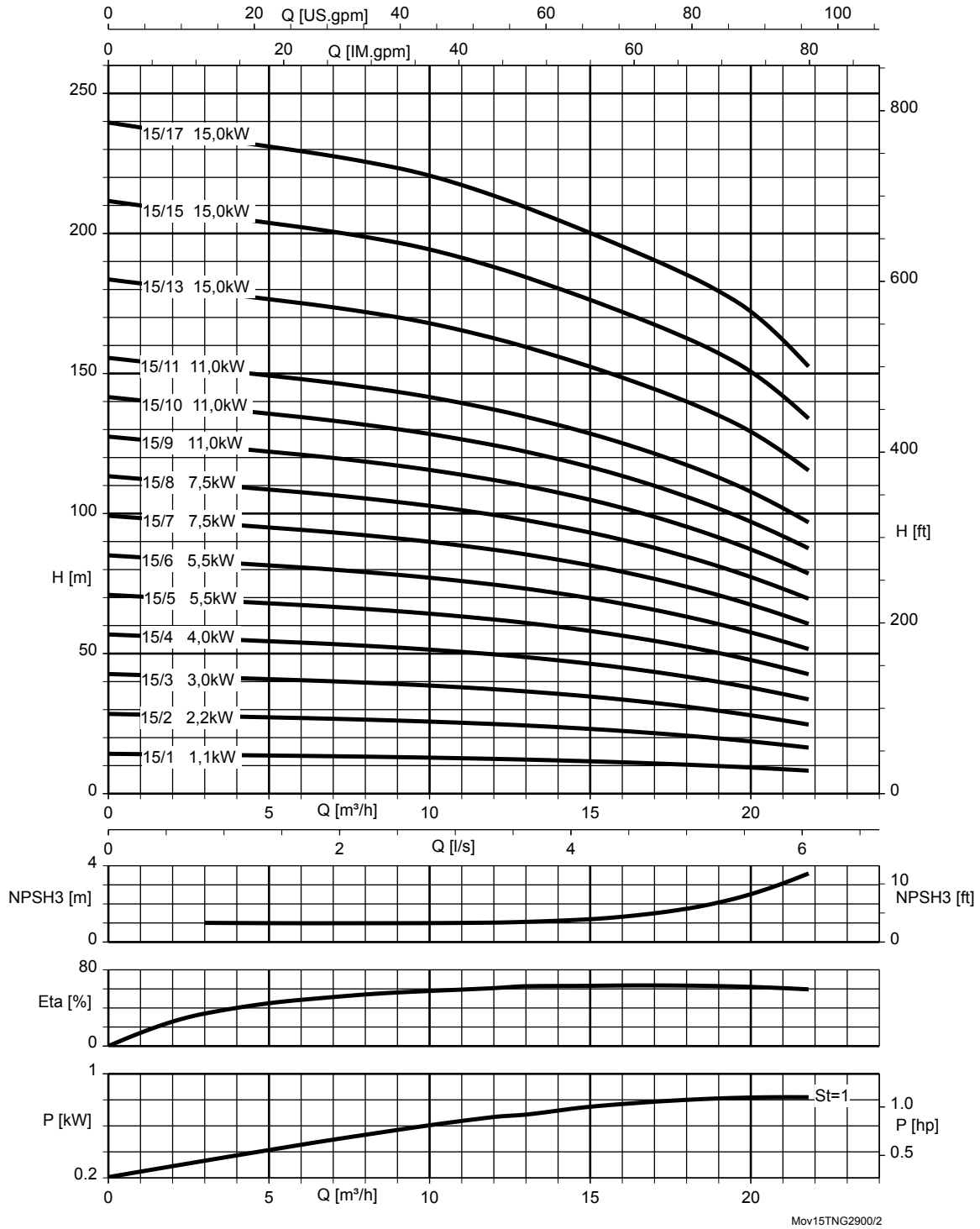

St = 1 | P per stage

Movitec, 15LB, n = 2900 rpm

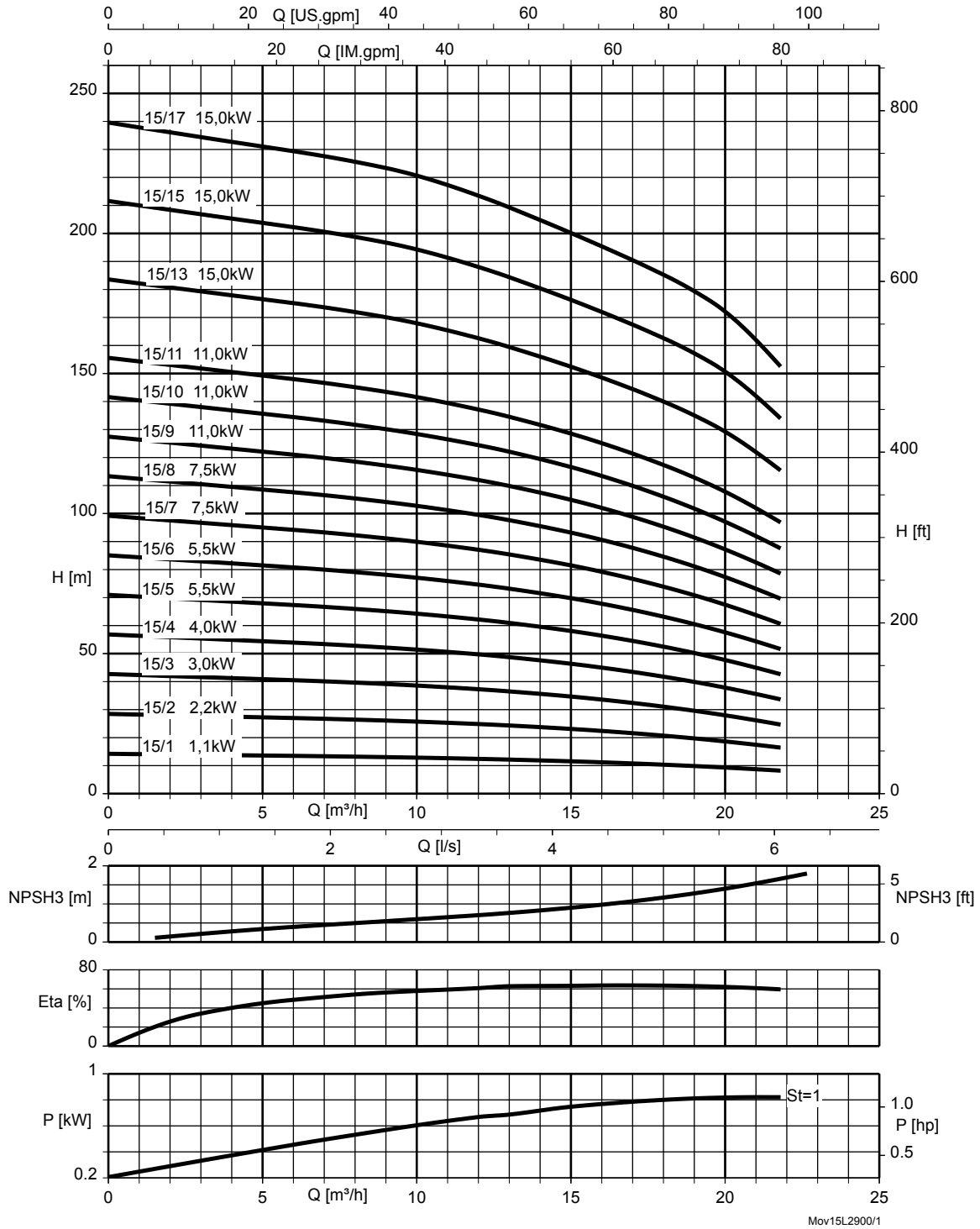

Mov15L2900/1

St = 1 | P per stage

Movitec, 25B, n = 2900 rpm

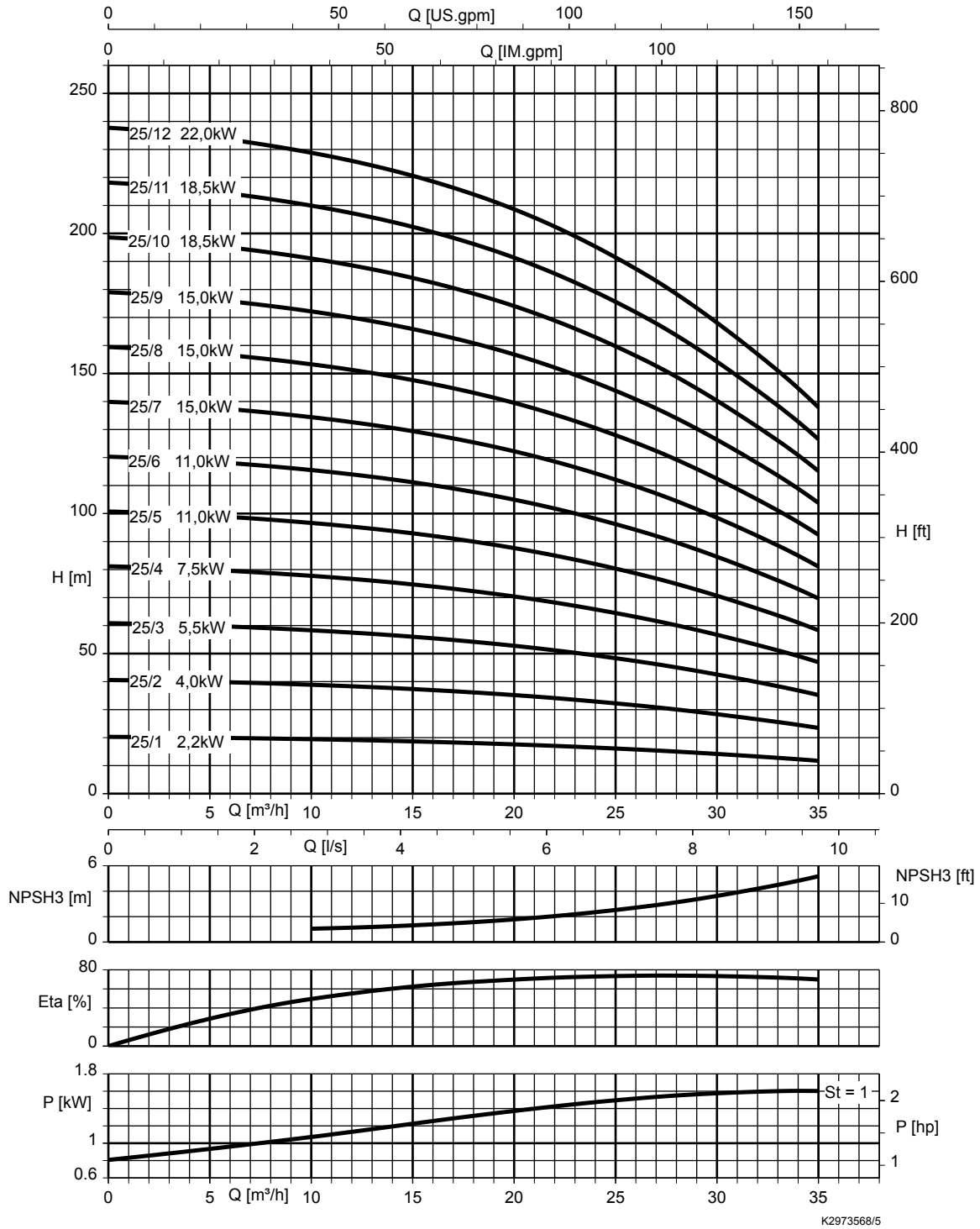

K2973568/5

St = 1 | P per stage

Movitec, 40B, n = 2900 rpm

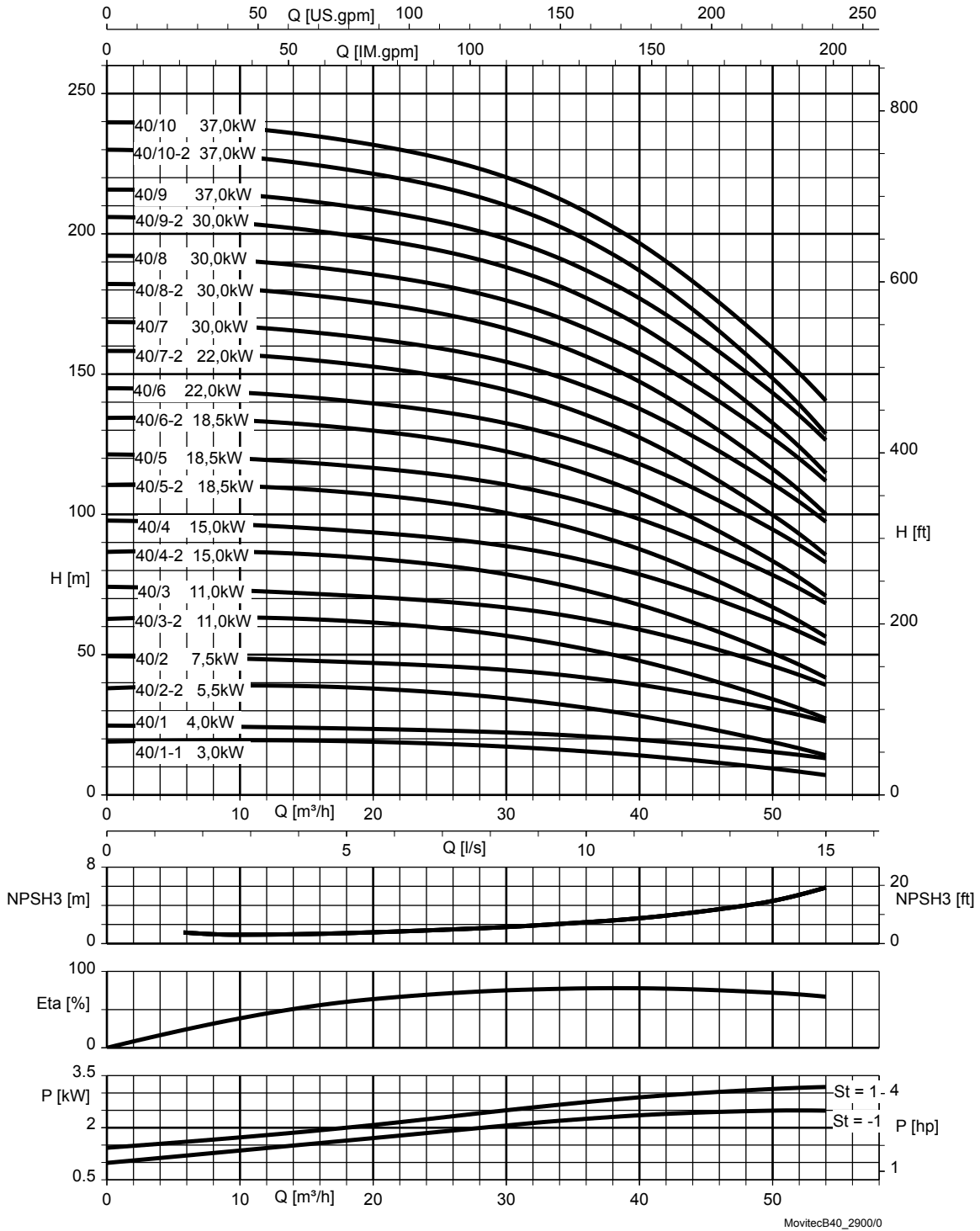

Movitec, 60B, n = 2900 rpm

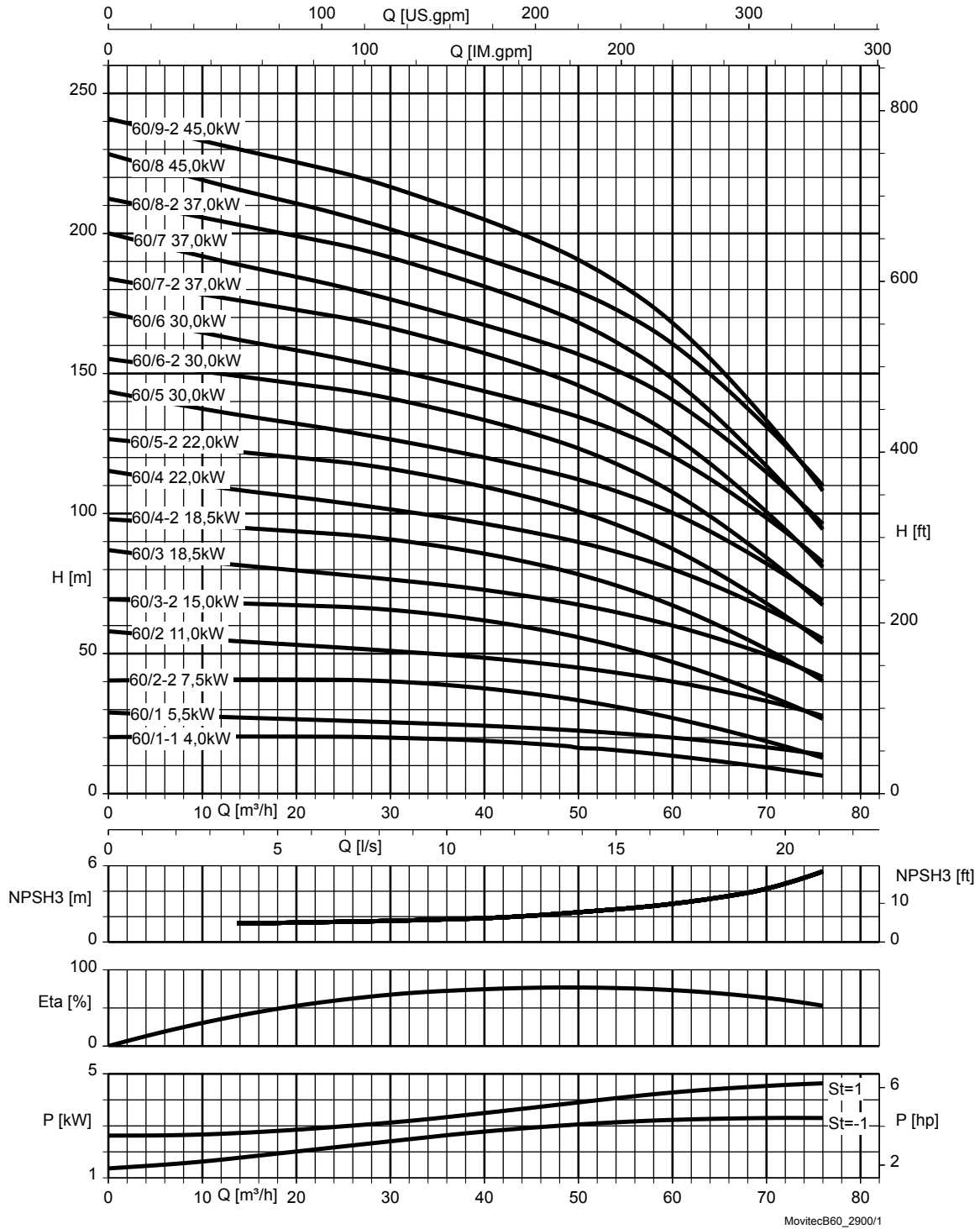

St = 1 P per stage	St = -1 P per stage with a smaller impeller
----------------------	---

Movitec, 90B, n = 2900 rpm

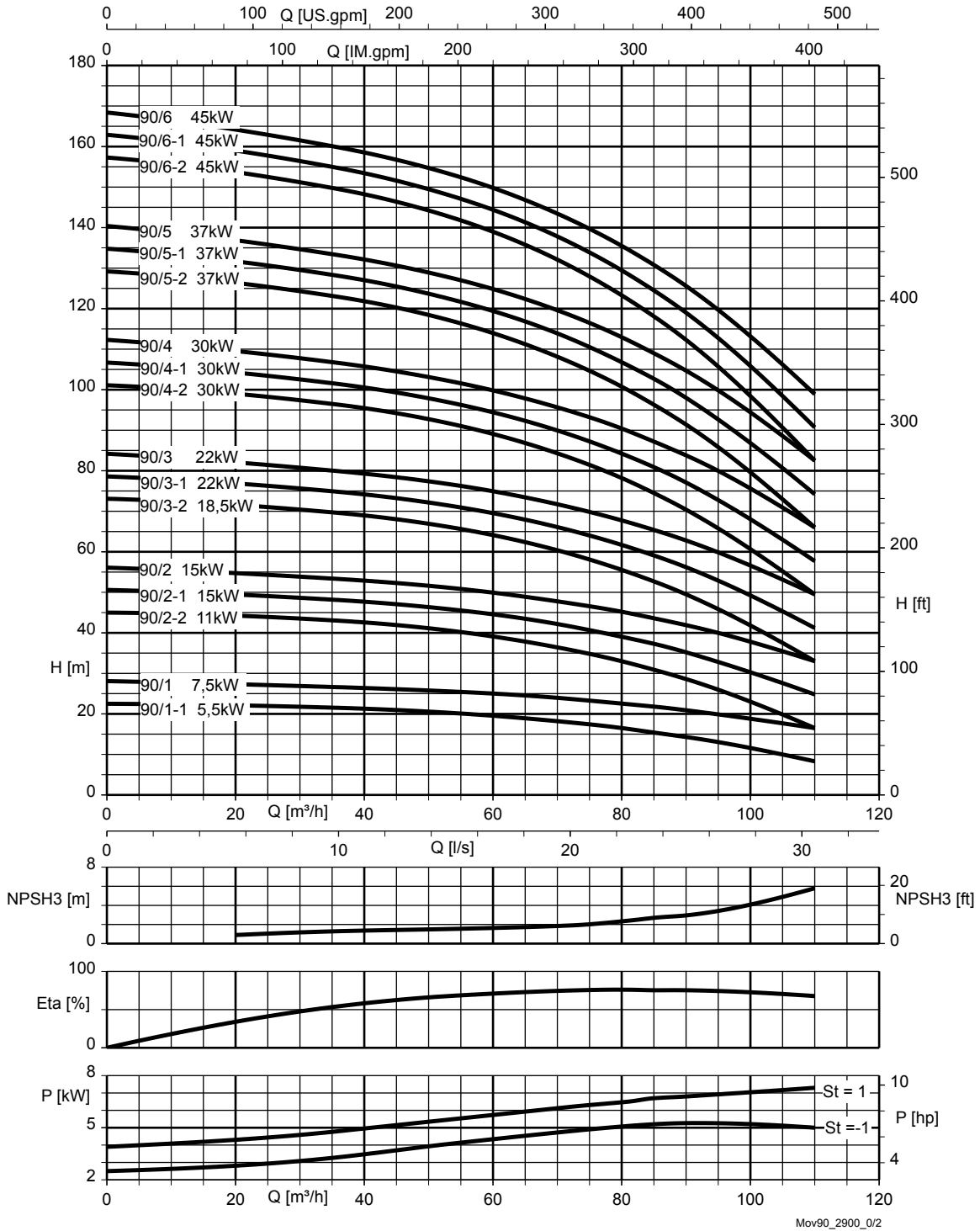

St = 1 | P per stage St = -1 | P per stage with a smaller impeller

Movitec, 125B, n = 2900 rpm

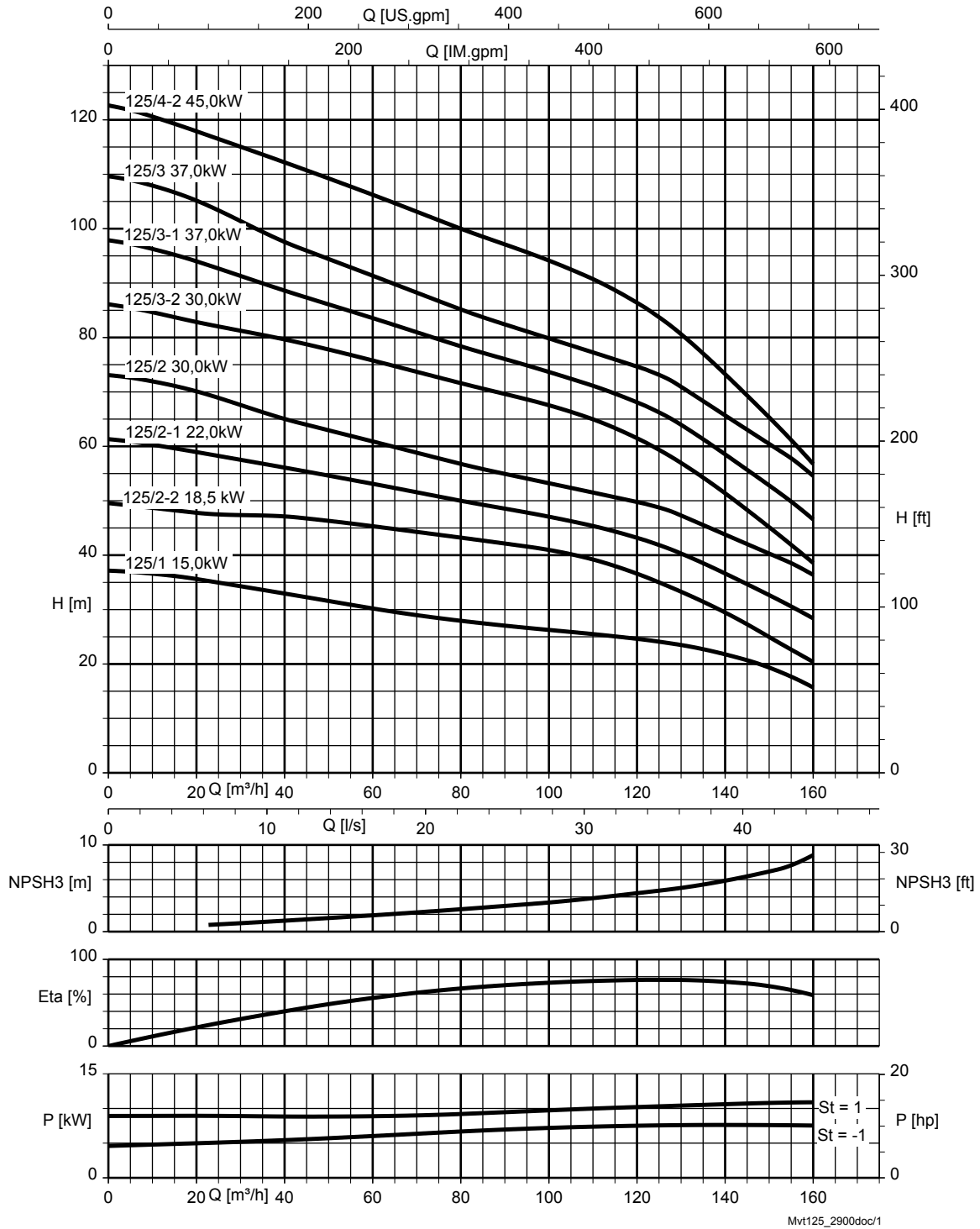

St = 1 P per stage	St = -1 P per stage with a smaller impeller
----------------------	---

Movitec, LHS 6, n = 2900 rpm

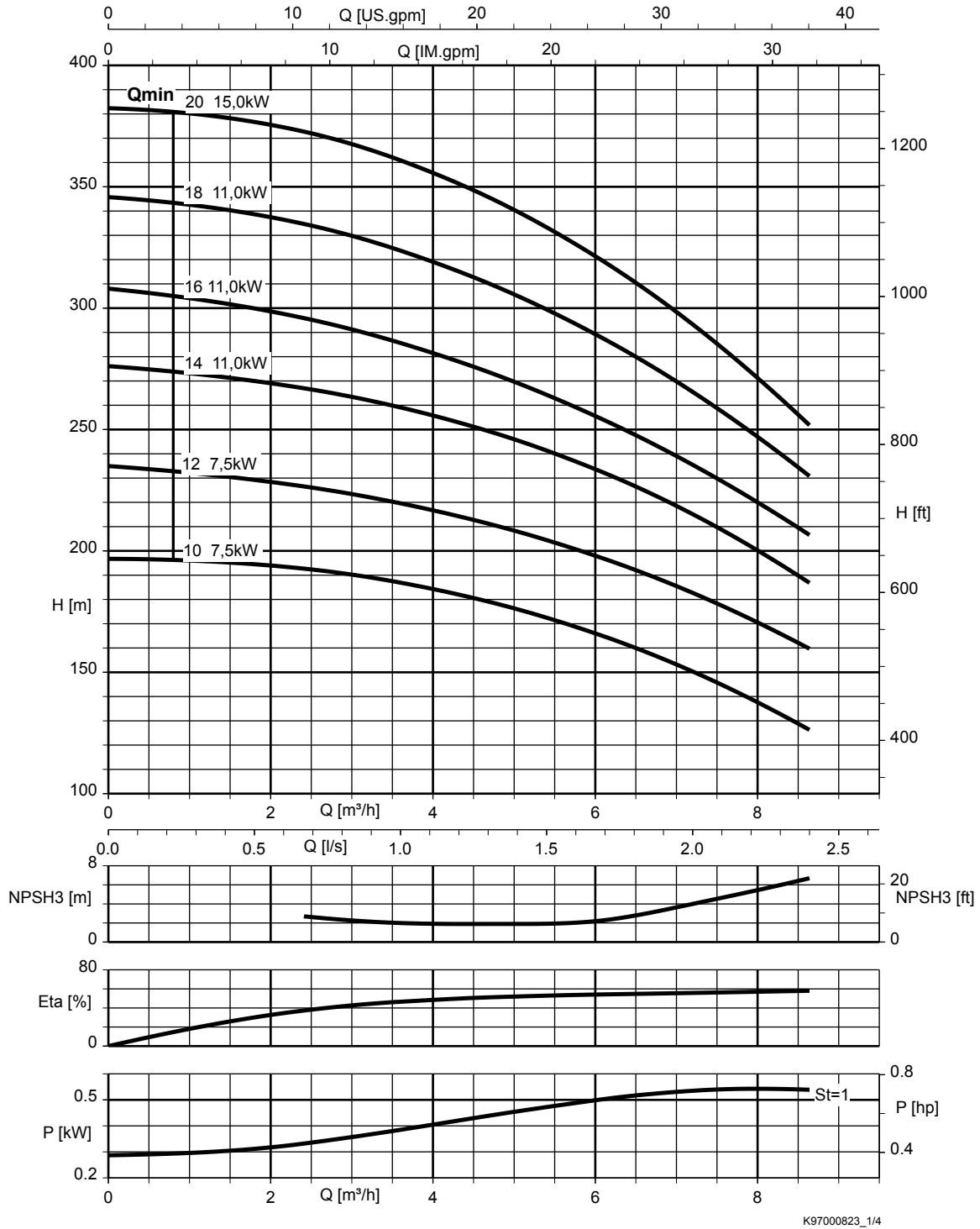

St = 1 | P per stage

*) $Q_{min} \leq 40 \text{ }^\circ\text{C}$

n = 1450 rpm

Movitec, 10B, n = 1450 rpm

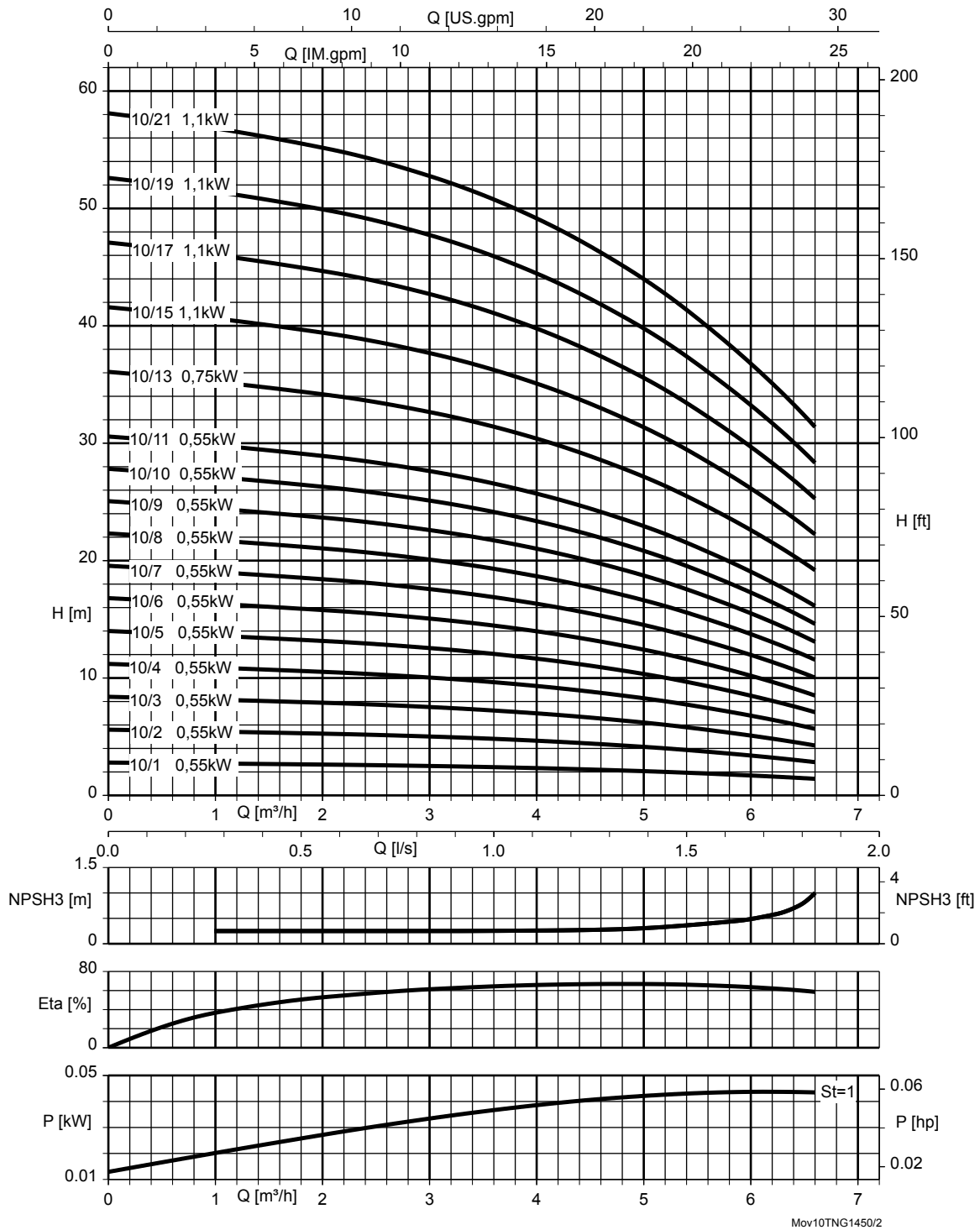

St = 1 | P per stage

Movitec, 10LB, n = 1450 rpm

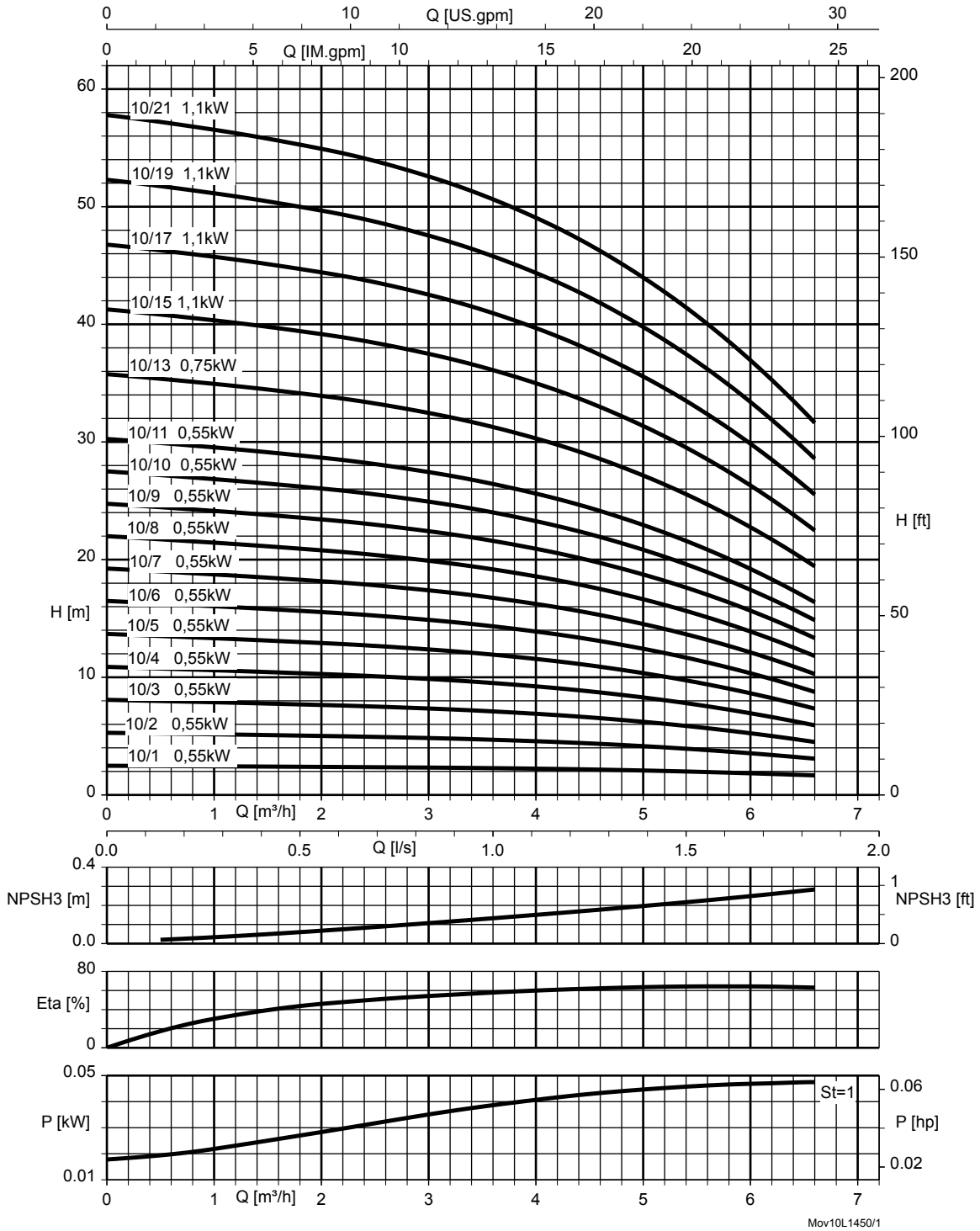

St = 1 | P per stage

Movitec, 15B, n = 1450 rpm

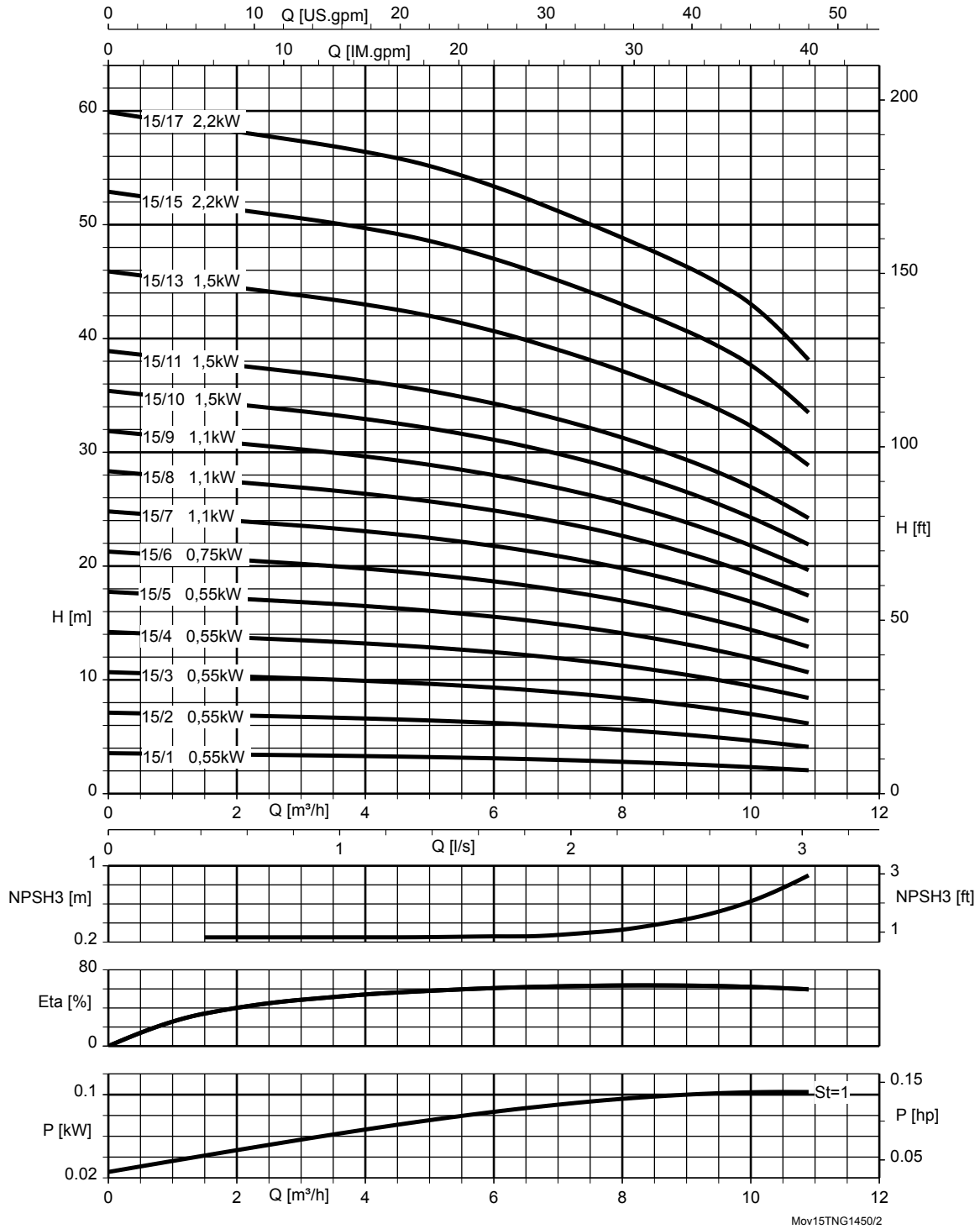

St = 1 | P per stage

Movitec, 15LB, n = 1450 rpm

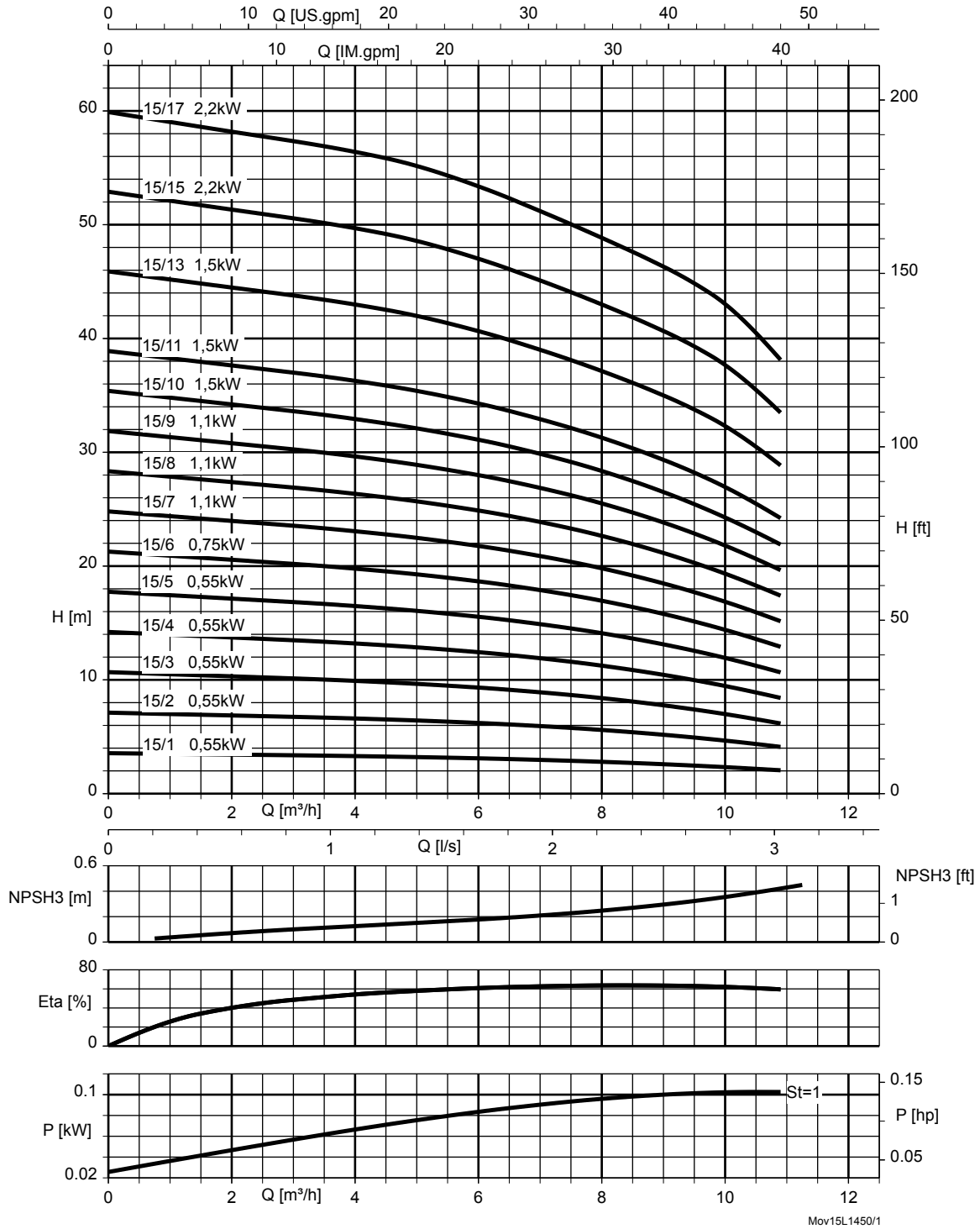

St = 1 | P per stage

Movitec, 25B, n = 1450 rpm

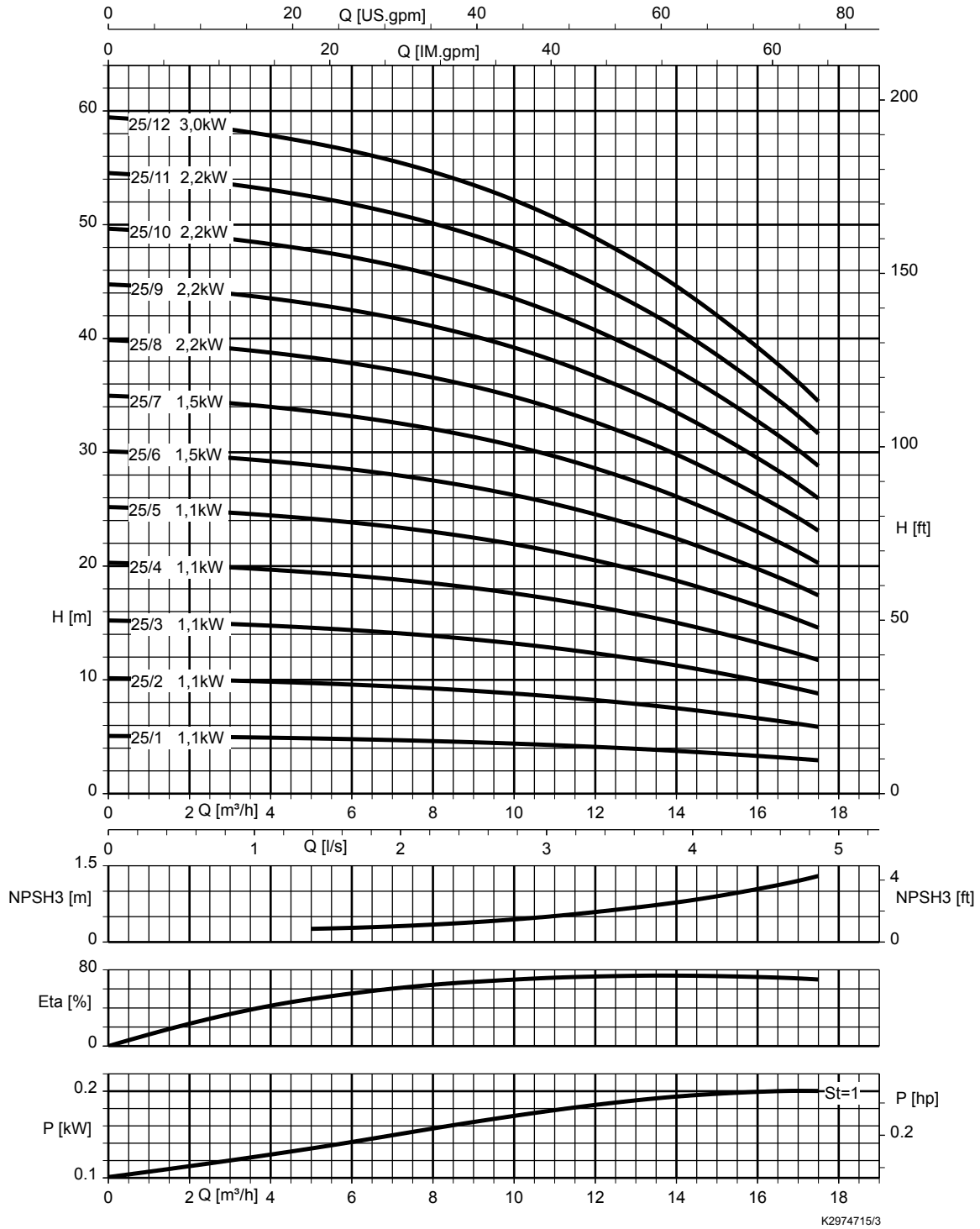

St = 1 | P per stage

Movitec, 40B, n = 1450 rpm

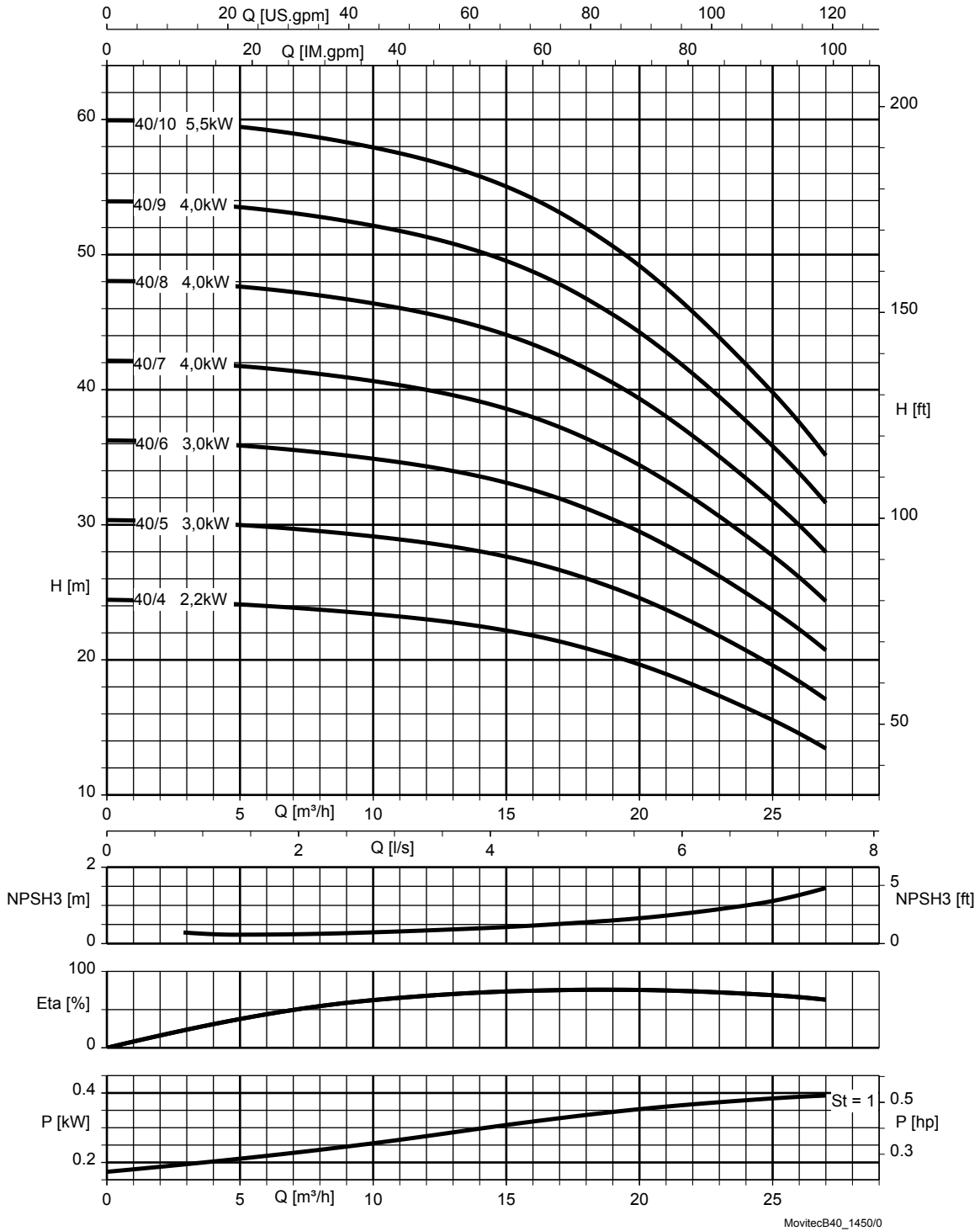

St = 1 | P per stage

Movitec, 60B, n = 1450 rpm

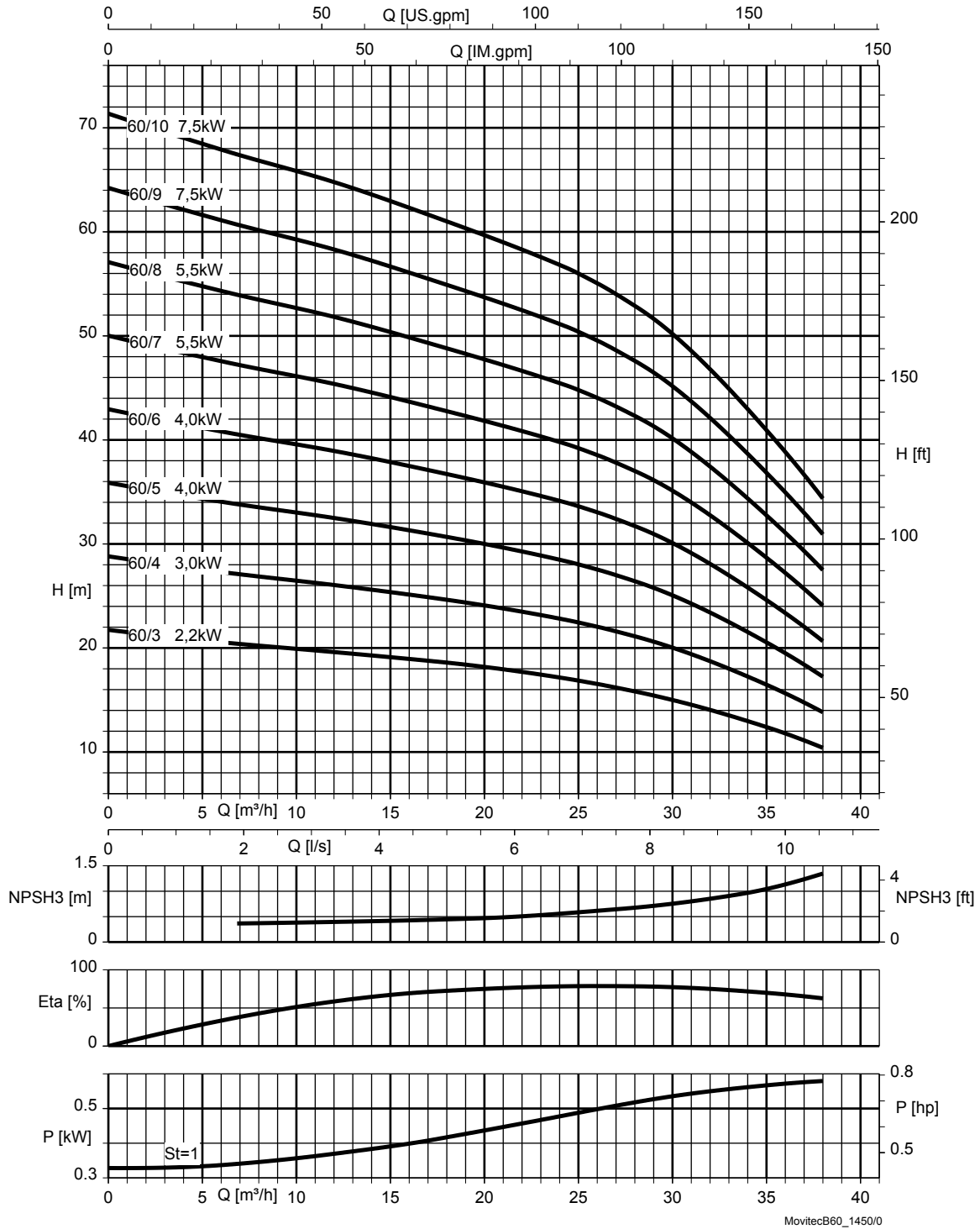

St = 1 | P per stage

Movitec, 90B, n = 1450 rpm

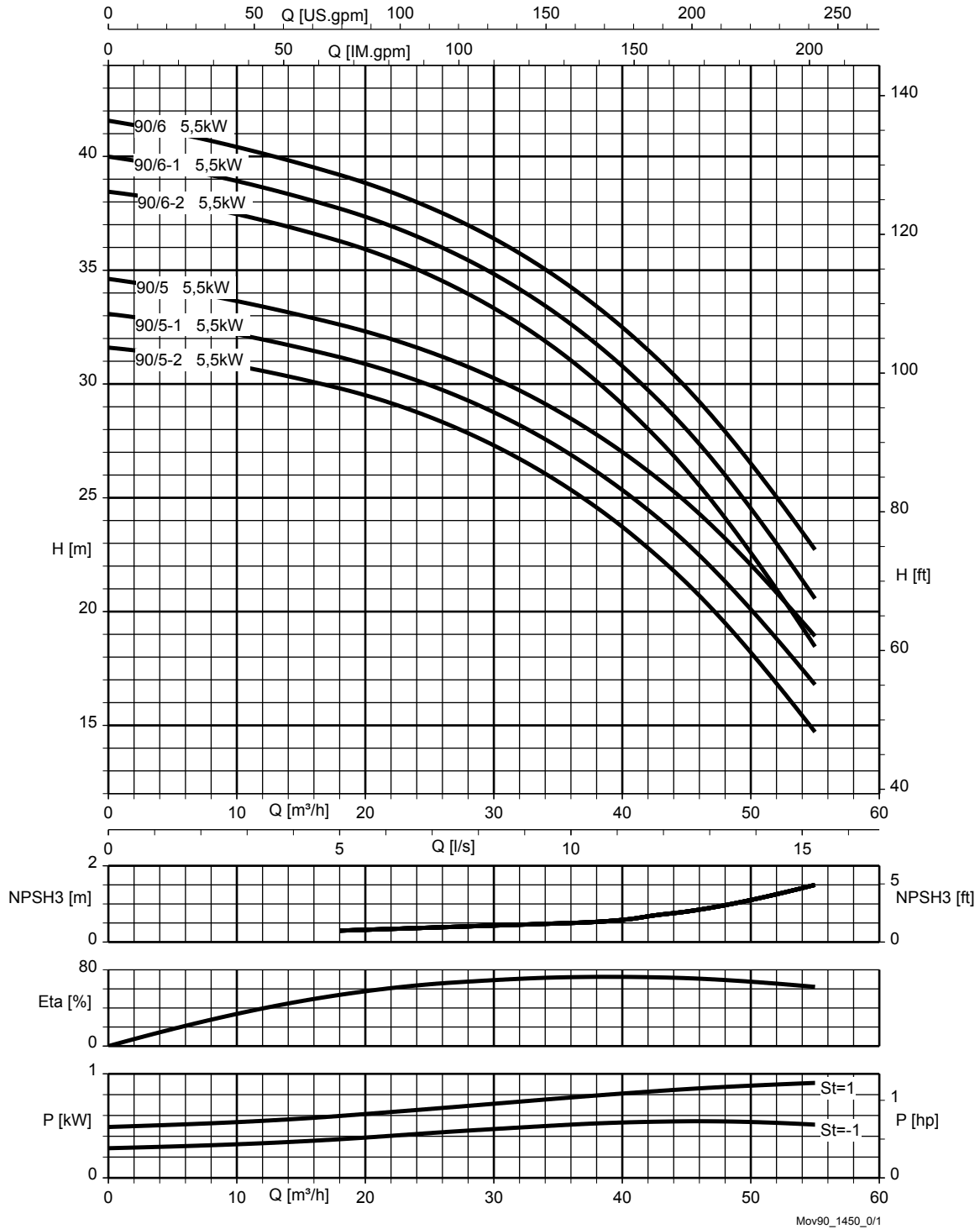

St = 1 | P per stage

Dimensions

Movitec, 2(L)B, n = 2900 rpm

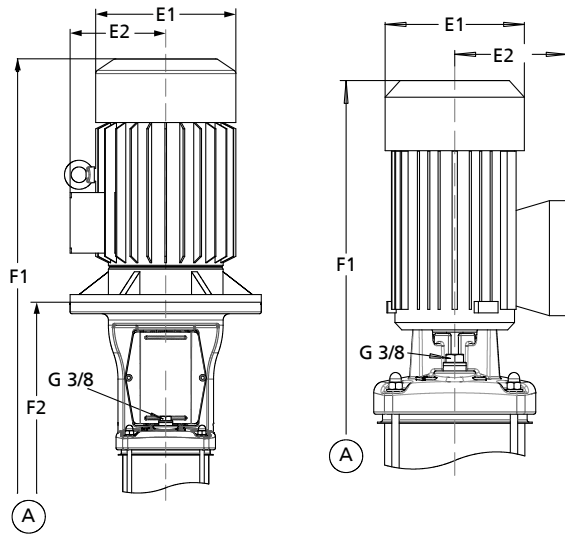

V(S), VE, V(S)V, V(S)T, V(C/S)F

VME

Dimensions

Number of stages	E1	E2	Movitec				
			V(S) ²²⁾ , VE ²²⁾ , V(S)V, V(S)T		V(C/S)F		VME
			F1	F2	F1	F2	F1
[mm]							
2	138	109	472	259	497	284	420
3	138	109	493	280	518	305	441
4	138	109	515	302	540	327	463
5	138	109	536	323	561	348	484
6	138	109	558	345	583	370	506
7	138	109	579	366	604	391	-
8	138	109	601	388	626	413	-
9	157	133	676	419	701	444	-
10	157	133	698	441	723	466	-
11	157	133	719	462	744	487	-
12	157	133	741	484	766	509	-
14	157	133	784	527	809	552	-
16	180	145	833	580	858	605	-
18	180	145	876	623	901	648	-
20	180	145	919	666	944	691	-
22	180	145	991	709	1016	734	-
24	180	145	1034	752	1059	777	-
26	180	145	1077	795	1102	820	-
28	180	145	1120	838	1145	863	-
30	180	145	1163	881	1188	906	-

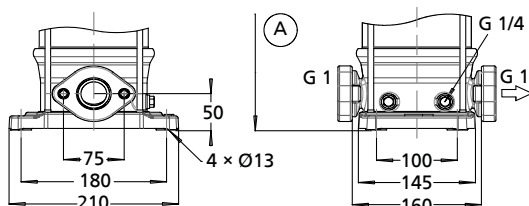

Fig. 4: Movitec V, VS

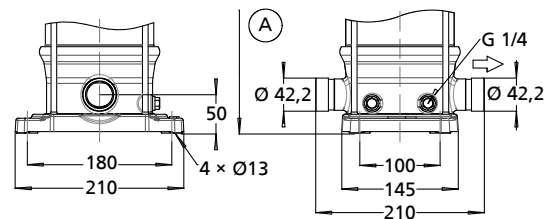

Fig. 5: Movitec VV, VSV

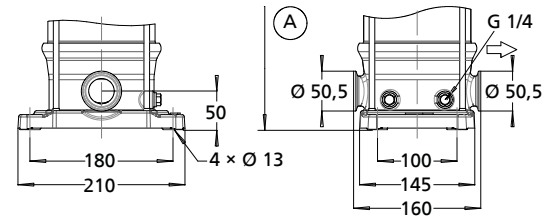

Fig. 6: Movitec VT, VST

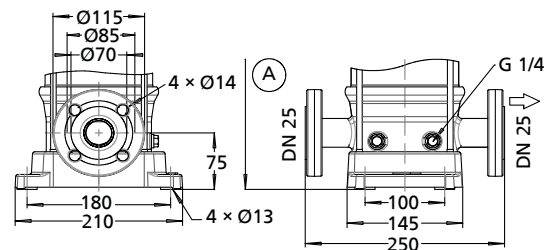

Fig. 7: Movitec VF, VSF

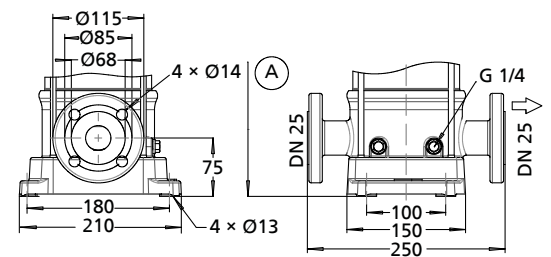

Fig. 8: Movitec VCF

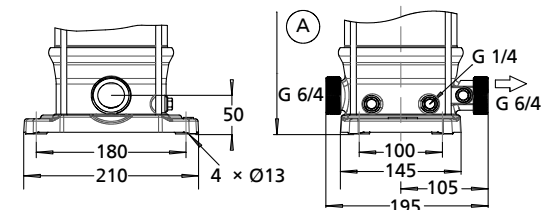
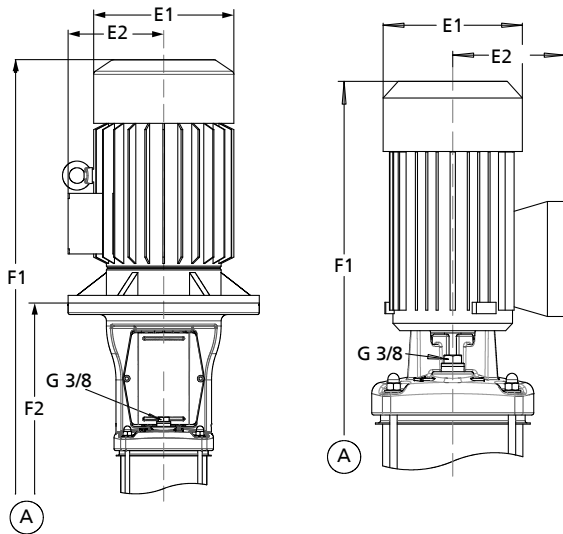

Fig. 9: Movitec VME

22) Available with a maximum of 20 stages

Movitec, 4(L)B, n = 2900 rpm



V(S), VE, V(S)V, V(S)T, V(C/S)F

VME

Dimensions

Number of stages	E1	E2	Movitec				
			V(S) ²³⁾ , VE ²³⁾ , V(S)V, V(S)T		V(C/S)F		VME
			F1	F2	F1	F2	F1
[mm]							
2	138	109	472	259	497	284	420
3	138	109	493	280	518	305	441
4	138	109	515	302	540	327	463
5	157	133	590	333	615	358	528
6	157	133	612	355	637	380	556
7	157	133	633	376	658	401	-
8	180	145	661	408	686	433	-
9	180	145	682	429	707	454	-
10	180	145	704	451	729	476	-
11	180	145	754	472	779	497	-
12	180	145	776	494	801	519	-
14	180	145	819	537	844	562	-
16	200	155	904	590	929	615	-
18	200	155	947	633	972	658	-
20	200	155	990	676	1015	701	-
22	223	166	1042	716	1067	744	-
24	223	166	1085	762	1110	787	-
26	223	166	1128	805	1153	830	-

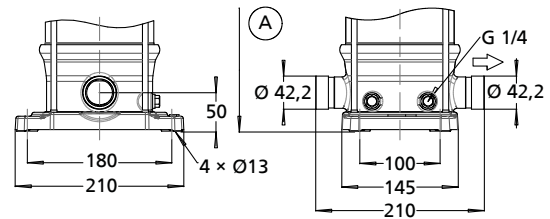

Fig. 11: Movitec VV, VSV

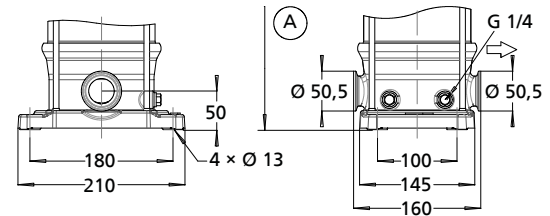

Fig. 12: Movitec VT, VST

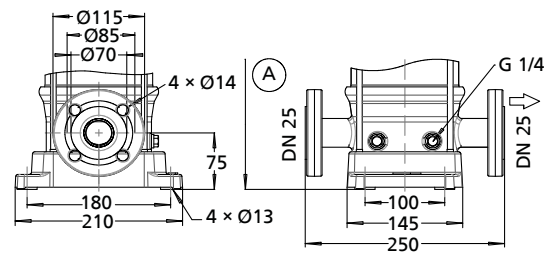

Fig. 13: Movitec VF, VSF

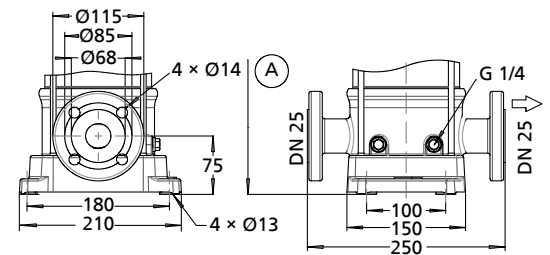

Fig. 14: Movitec VCF

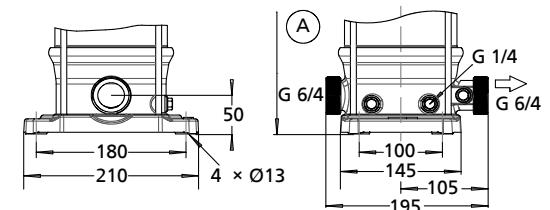

Fig. 15: Movitec VME

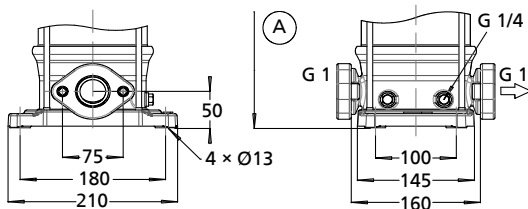
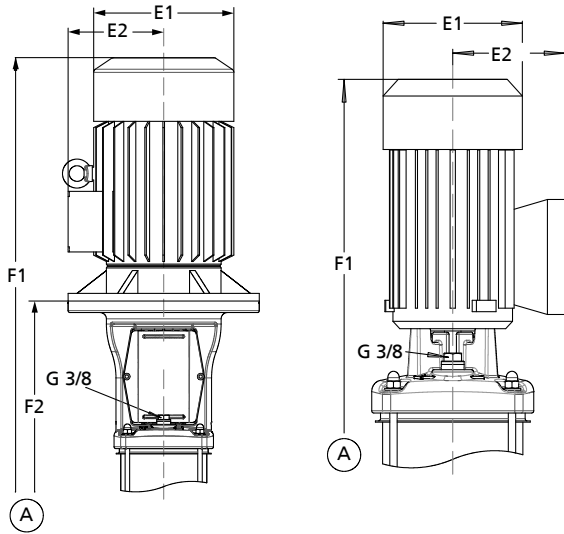

Fig. 10: Movitec V, VS

23) Available with a maximum of 16 stages

Movitec, 6(L)B, n = 2900 rpm



V(S), VE, V(S)V, V(S)T, V(C/S)F

VME

Dimensions

Number of stages	E1	E2	Movitec				
			V(S) ²⁴⁾ , VE ²⁴⁾ , V(S)V, V(S)T		V(C/S)F		VME
			F1	F2	F1	F2	F1
[mm]							
2	138	109	479	266	504	291	427
3	157	133	558	301	563	326	496
4	157	133	583	326	608	351	521
5	157	133	608	351	633	376	546
6	180	145	639	386	664	411	-
7	180	145	664	411	689	436	-
8	180	145	718	436	743	461	-
9	180	145	743	461	768	486	-
10	180	145	768	486	793	511	-
11	200	155	835	521	860	546	-
12	200	155	860	546	885	571	-
14	200	155	910	596	935	621	-
16	223	166	869	646	994	671	-
18	223	166	1019	696	1044	721	-
20	260	190	1168	822	1193	847	-
22	260	190	1218	872	1243	897	-
24	260	190	1268	922	1293	947	-
26	260	190	1318	972	1343	997	-

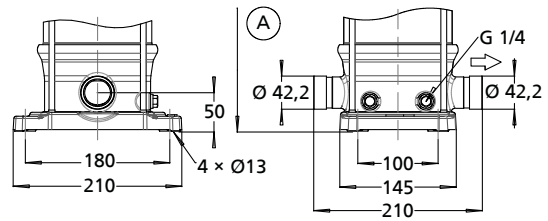

Fig. 17: Movitec VV/VSV

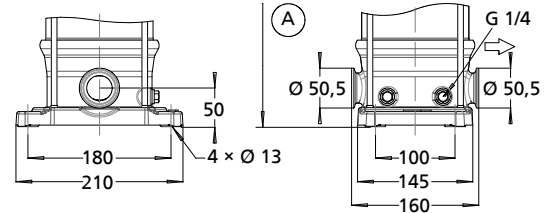

Fig. 18: Movitec VT/VST

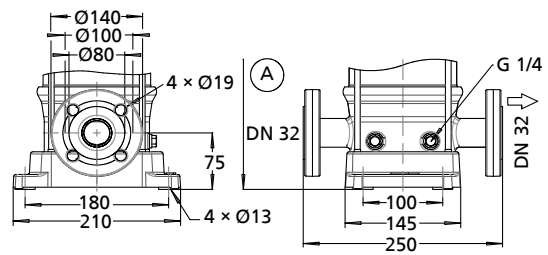

Fig. 19: Movitec VF/VSF

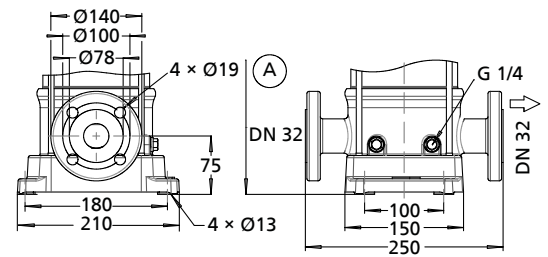

Fig. 20: Movitec VCF

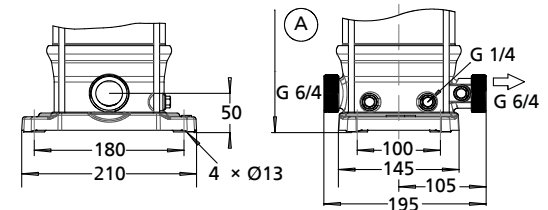

Fig. 21: Movitec VME

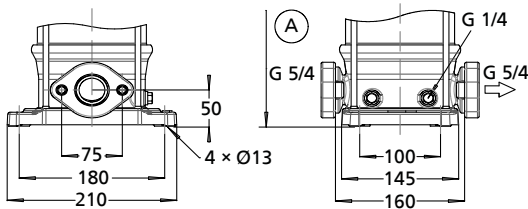
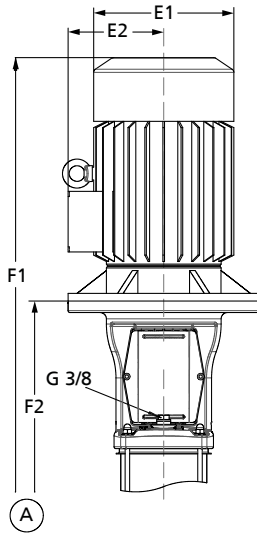

Fig. 16: Movitec VVS

24) Available with a maximum of 16 stages

Movitec, 10(L)B, n = 1450 rpm



V(S), V(S)V, V(S)T, V(C/S)F

Dimensions

Number of stages	E1	E2	Movitec			
			V(S), V(S)V, V(S)T		V(C/S)F	
			F1	F2	F1	F2
[mm]						
1	157	112	592	346	592	346
2	157	112	592	346	592	346
3	157	112	618	372	618	372
4	157	112	645	399	645	399
5	157	112	671	425	671	425
6	157	112	698	452	698	452
7	157	112	724	478	724	478
8	157	112	750	505	750	505
9	157	112	777	531	777	531
10	157	112	804	558	804	558
11	157	112	830	584	830	584
13	157	112	912	672	912	672
15	180	145	970	700	970	700
17	180	145	1023	733	1023	753
19	180	145	1076	806	1076	806
21	180	145	1129	859	1129	859

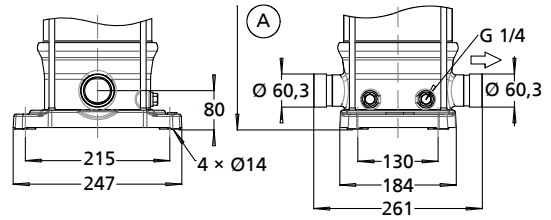

Fig. 23: Movitec VV, VSV

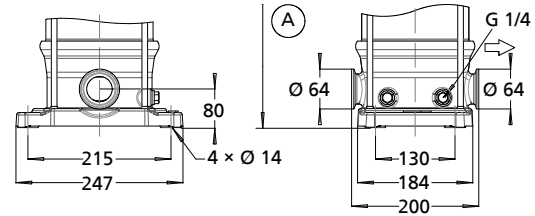

Fig. 24: Movitec VT, VST

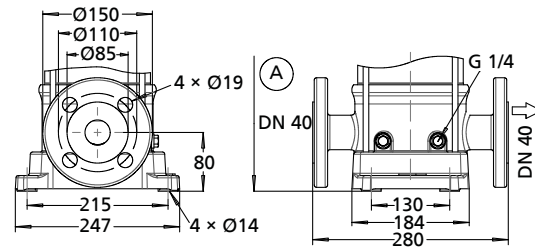

Fig. 25: Movitec VF, VSF

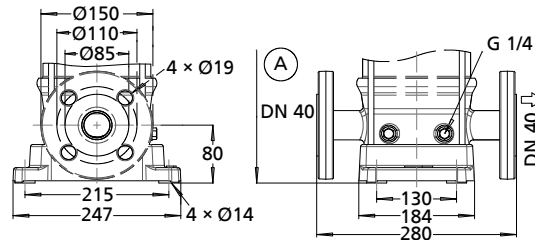

Fig. 26: Movitec VCF

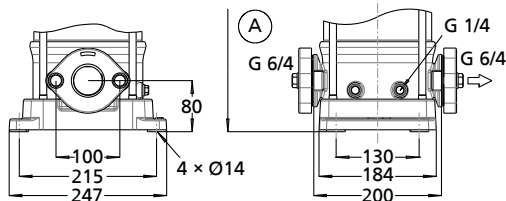
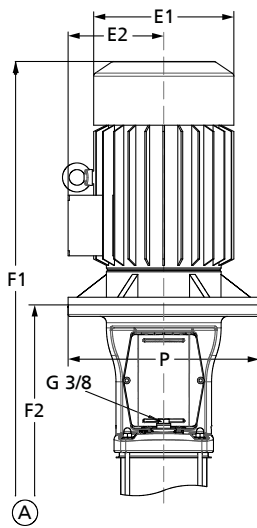

Fig. 22: Movitec V, VS

Movitec, 10(L)B, n = 2900 rpm



V(S), V(S)V, V(S)T, V(C/S)F

Dimensions

Number of stages	E1	E2	p ²⁵⁾	Movitec			
				V(S) ²⁶⁾ , V(S)V, V(S)T		V(C/S)F	
				F1	F2	F1	F2
[mm]							
1	157	133	-	621	346	621	346
2	157	133	-	621	346	621	346
3	157	133	-	647	372	647	372
4	180	145	-	679	409	679	409
5	180	145	-	720	435	720	435
6	180	145	-	747	462	747	462
7	200	155	-	828	498	828	498
8	200	155	-	855	525	855	525
9	223	166	-	891	551	891	551
10	223	166	-	918	578	918	578
11	223	166	-	944	604	944	604
13	260	190	300	1102	737	1102	737
15	260	190	300	1155	790	1155	790
17	260	190	300	1208	843	1208	843
19	260	190	300	1261	896	1261	896
21	260	190	300	1314	949	1314	949

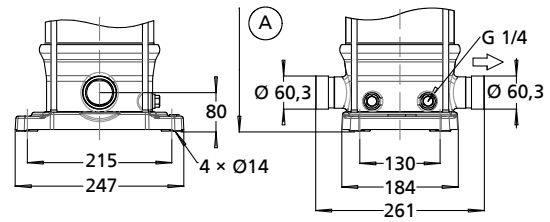

Fig. 28: Movitec VV, VSV

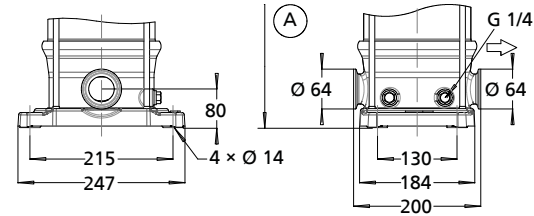

Fig. 29: Movitec VT, VST

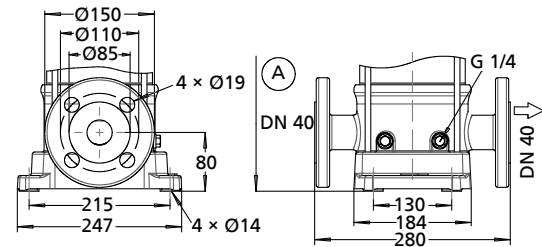

Fig. 30: Movitec VF, VSF

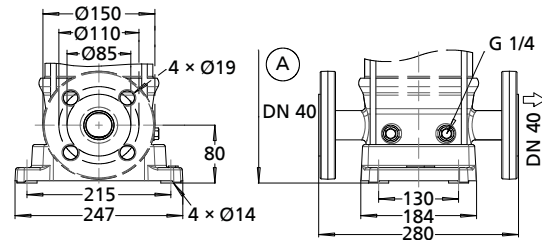

Fig. 31: Movitec VCF

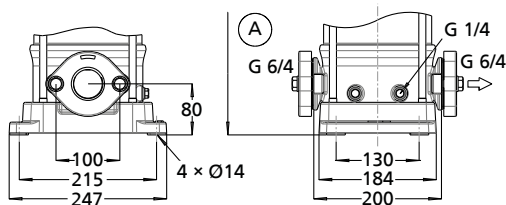
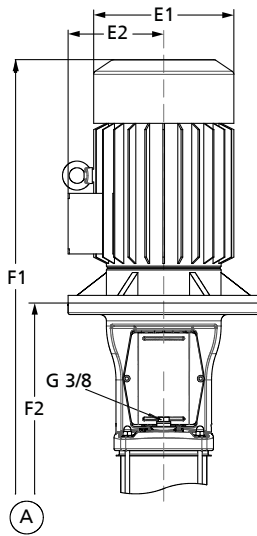

Fig. 27: Movitec V, VS

25) Only relevant for motors > 5.5 kW
26) Available with a maximum of 13 stages

Movitec, 15(L)B, n = 1450 rpm



V(S), V(S)V, V(S)T, V(C/S)F

Dimensions

Number of stages	E1	E2	Movitec			
			V(S), V(S)V, V(S)T		V(C/S)F	
			F1	F2	F1	F2
[mm]						
1	157	112	592	346	602	356
2	157	112	592	346	602	356
3	157	112	618	372	628	382
4	157	112	645	399	655	409
5	157	112	671	425	681	435
6	157	112	727	452	737	462
7	180	145	758	488	768	498
8	180	145	785	515	795	525
9	180	145	811	541	821	551
10	180	145	853	568	863	578
11	180	145	879	594	889	604
13	180	145	932	647	942	657
15	200	155	1040	710	1050	720
17	200	155	1093	763	1103	773

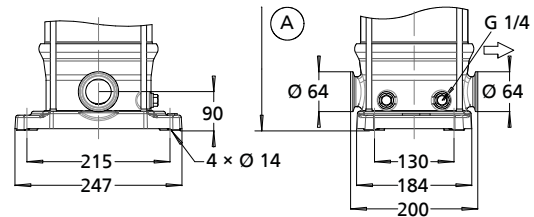

Fig. 34: Movitec VT, VST

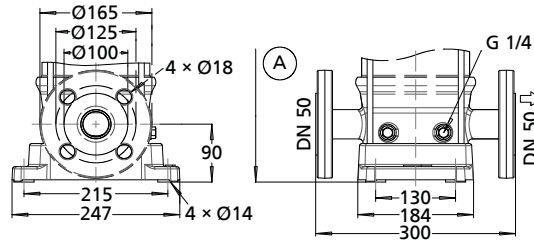

Fig. 35: Movitec VF, VSF

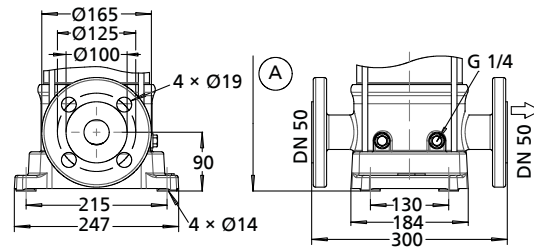

Fig. 36: Movitec VCF

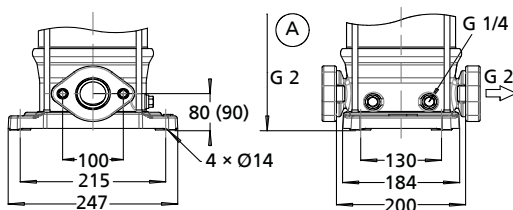

Fig. 32: Movitec V, VS

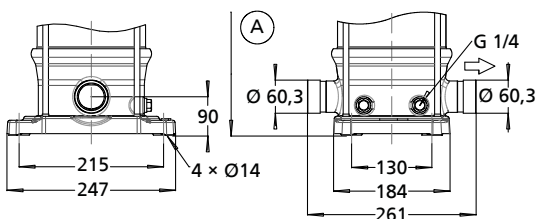
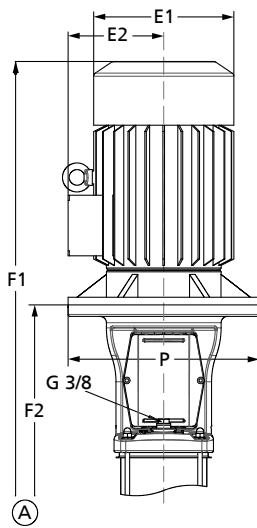

Fig. 33: Movitec VV, VSV

Movitec, 15(L)B, n = 2900 rpm



V(S), V(S)V, V(S)T, V(C/S)F

Dimensions

Number of stages	E1	E2	p ²⁷⁾	Movitec			
				V(S) ²⁸⁾ , V(S)V, V(S)T		V(C/S)F	
				F1	F2	F1	F2
[mm]							
1	157	133	-	621	346	631	356
2	180	145	-	641	356	651	366
3	200	155	-	722	392	732	402
4	223	166	-	759	419	769	429
5	260	190	300	890	525	900	535
6	260	190	300	916	551	926	561
7	260	190	300	943	578	953	588
8	260	190	300	969	604	979	614
9	315	260	350	1159	661	1169	671
10	315	260	350	1185	687	1195	697
11	315	260	350	1222	724	1222	724
13	315	260	350	1275	777	1275	777
15	315	260	350	1328	830	1328	830
17	315	260	350	1381	883	1381	883

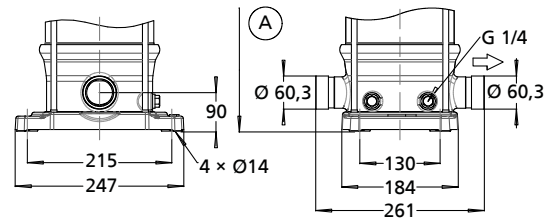

Fig. 38: Movitec VV, VSV

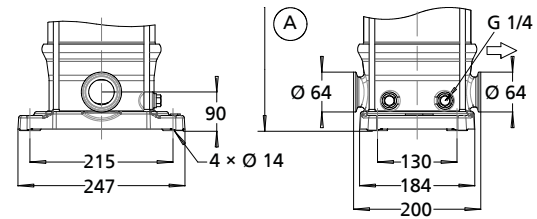

Fig. 39: Movitec VT, VST

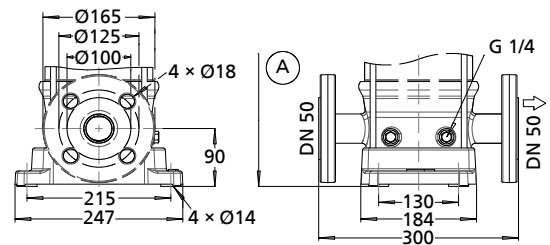

Fig. 40: Movitec VF, VSF

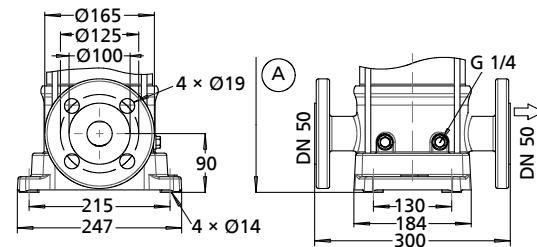

Fig. 41: Movitec VCF

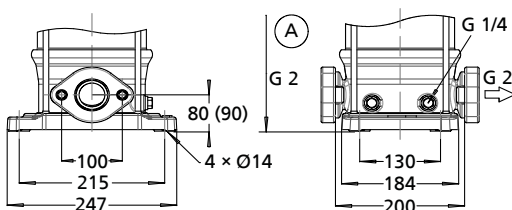
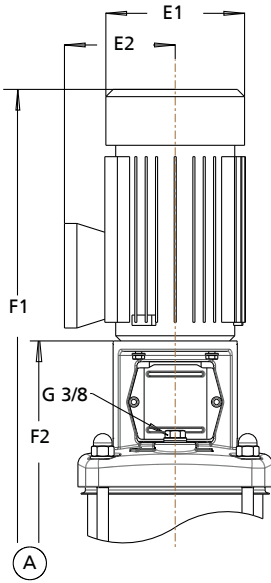

Fig. 37: Movitec V, VS

27) Dimensions relevant for motors > 5.5 kW
28) Available with a maximum of 11 stages

Movitec, 25B, n = 1450 rpm



V(C/S)F
Motor flange version with
tapped hole

Dimensions

Number of stages	E1	E2	Movitec	
			V(C/S)F	
			F1	F2
[mm]				
1	180	145	678	408
2	180	145	743	473
3	180	145	808	538
4	180	145	873	603
5	180	145	938	668
6	180	145	1018	733
7	180	145	1083	798
8	200	155	1198	868
9	200	155	1263	933
10	200	155	1328	998
11	200	155	1393	1063
12	200	155	1458	1128

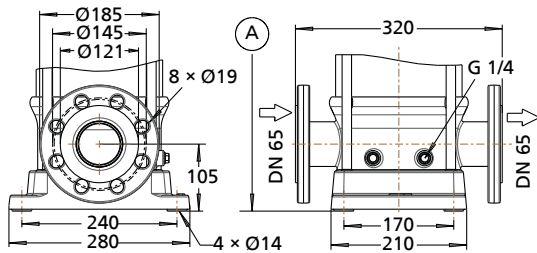

Fig. 42: Movitec VF, VSF

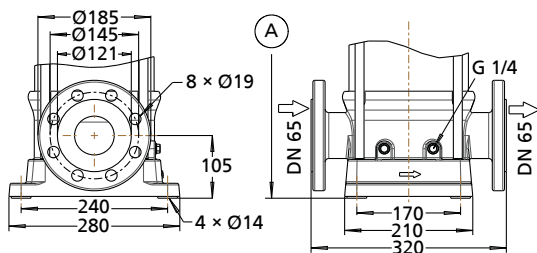
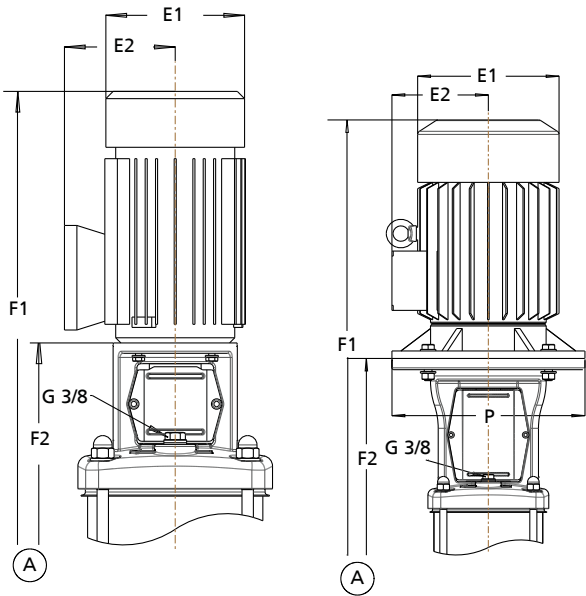

Fig. 43: Movitec VCF

Movitec, 25B, n = 2900 rpm



V(C/S)F
Motor flange version with
tapped holes

V(C/S)F
Motor flange version with
clearance holes

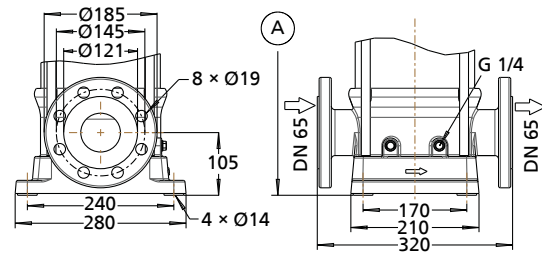

Fig. 45: Movitec VCF

Dimensions

Motor flange version with tapped holes

Number of stages	E1	E2	P	Movitec	
				V(C/S)F	
				F1	F2
[mm]					
1	180	145	-	693	408
2	223	166	-	818	478

Dimensions

Motor flange version with clearance holes

Number of stages	E1	E2	P	Movitec	
				V(C/S)F	
				F1	F2
[mm]					
3	260	190	300	999	634
4	260	190	300	1064	699
5	315	260	350	1292	794
6	315	260	350	1357	859
7	315	260	350	1422	924
8	315	260	350	1487	989
9	315	260	350	1552	1054
10	315	265	350	1699	1119
11	315	265	350	1764	1184
12	360	275	350	1829	1249

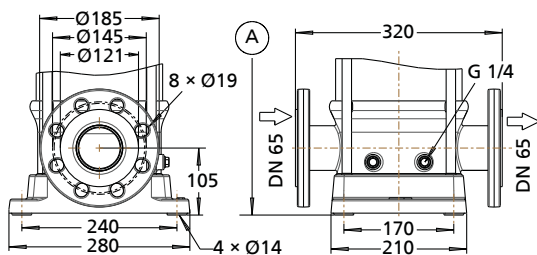

Fig. 44: Movitec VF, VSF

Movitec, 40B, n = 1450 rpm

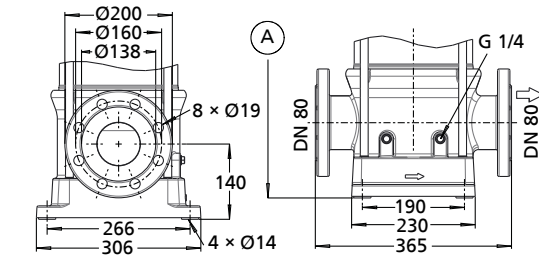
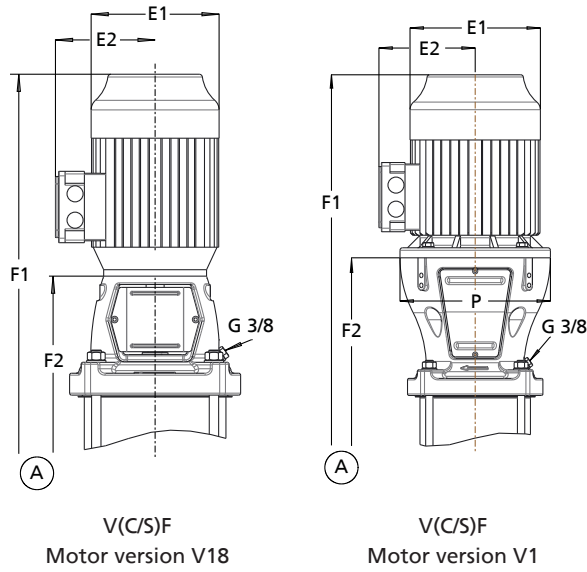

Fig. 48: Movitec VCF

Dimensions, motor version V18

Number of stages	E1	E2	P	Movitec V(C/S)F	
				F1	F2
				[mm]	
4	200	155	-	1051	721
5	200	155	-	1129	799
6	200	155	-	1207	877
7	233	166	-	1306	955
8	233	166	-	1384	1033
9	233	166	-	1462	1111

Dimensions, motor version V1

Number of stages	E1	E2	P	Movitec VF, VSF, VCF	
				F1	F2
				[mm]	
10	260	190	300	1664	1279

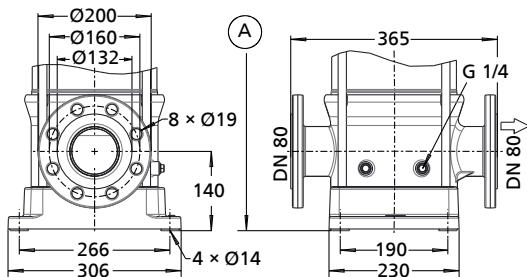

Fig. 46: Movitec VF, VSF

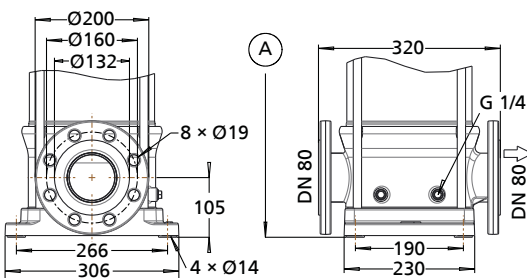
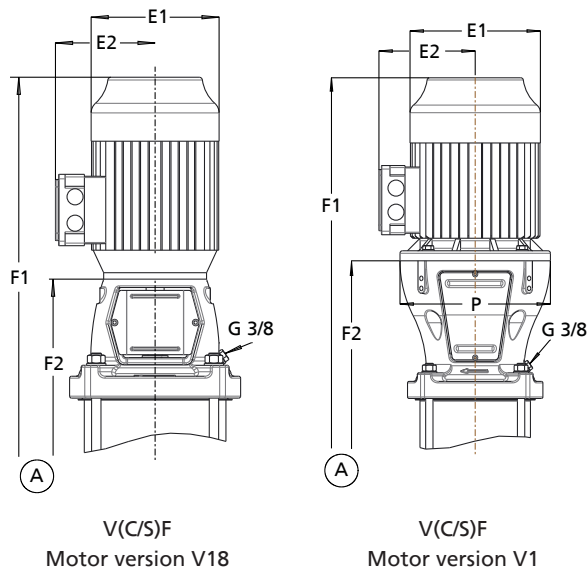

Fig. 47: Movitec VF, VSF - interchangeable range

Movitec, 40B, n = 2900 rpm



Dimensions, motor version V18

Number of stages – Number of stages with smaller impellers	E1	E2	P	Movitec V(C/S)F	
				F1	F2
	[mm]				
1-1	200	155	-	817	487
1	223	166	-	827	487

Dimensions, motor version V1

Number of stages – Number of stages with smaller impellers	E1	E2	P	Movitec V(C/S)F	
				F1	F2
	[mm]				
2-2	260	190	300	1002	655
2	260	190	300	1002	655
3-2	315	260	350	1261	763
3	315	260	350	1261	763
4-2	315	260	350	1339	841
4	315	260	350	1339	841
5-2	315	265	350	1499	919
5	315	265	350	1499	919
6-2	315	265	350	1577	997
6	360	275	350	1577	997
7-2	360	275	350	1655	1075
7	400	340	400	1725	1075
8-2	400	340	400	1803	1153
8	400	340	400	1803	1153
9-2	400	340	400	1881	1231
9	400	340	400	1881	1231
10-2	400	340	400	1959	1309
10	400	340	400	1959	1309

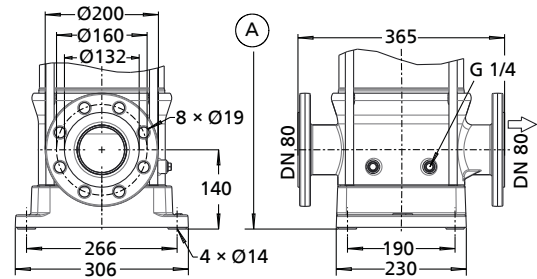

Fig. 49: Movitec VF, VSF; PN 16, 25

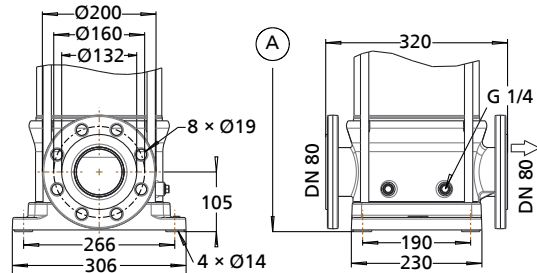

Fig. 50: Movitec VF, VSF; PN 16, 25 - interchangeable range

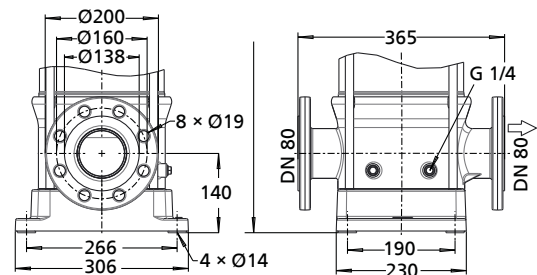

Fig. 51: Movitec VF, VSF; PN 40

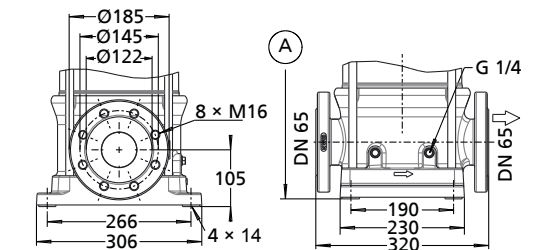

Fig. 52: Movitec VCF; DN 65

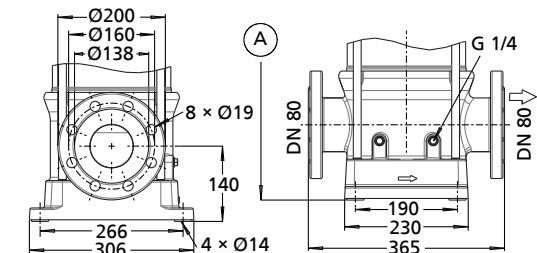
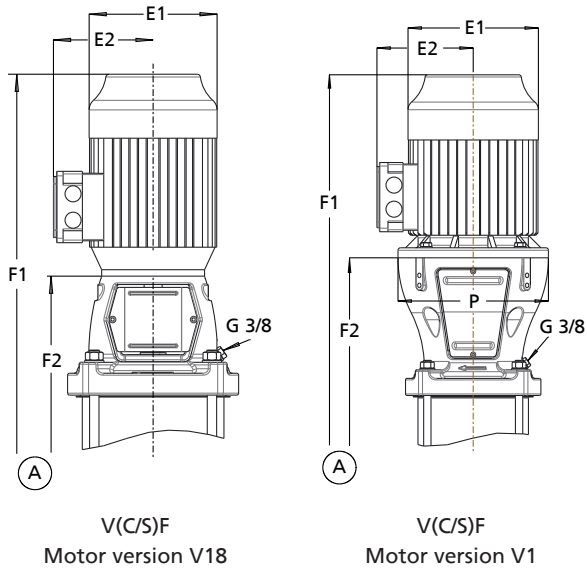

Fig. 53: Movitec VCF; DN 80

Movitec, 60B, n = 1450 rpm



Dimensions, motor version V18

Number of stages	E1	E2	P	Movitec V(C/S)F	
				F1	F2
				[mm]	
3	200	155	-	973	643
4	200	155	-	1051	721
5	233	166	-	1150	799
6	233	166	-	1228	877

Dimensions, motor version V1

Number of stages	E1	E2	P	Movitec V(C/S)F	
				F1	F2
				[mm]	
7	260	190	300	1430	1045
8	260	190	300	1508	1123
9	260	190	300	1586	1201
10	260	190	300	1664	1279

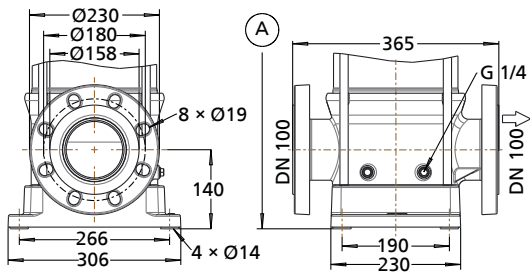

Fig. 54: Movitec VF/VSF

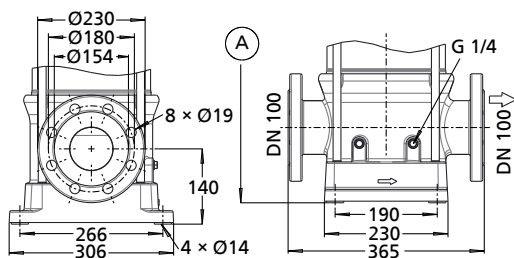
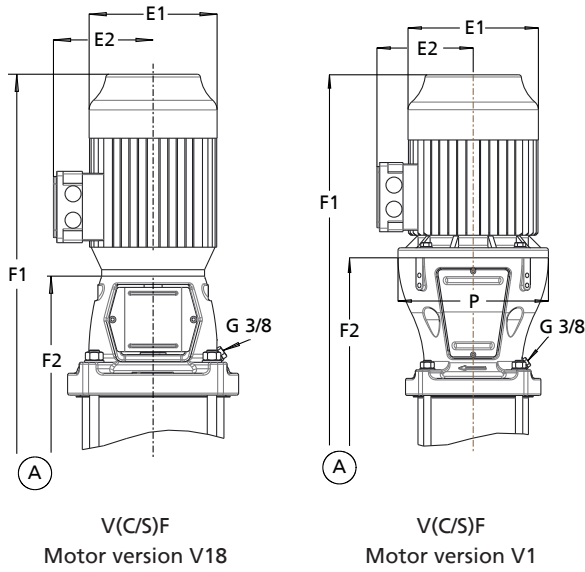

Fig. 55: Movitec VCF

Movitec, 60B, n = 2900 rpm



V(C/S)F
Motor version V18

V(C/S)F
Motor version V1

Dimensions, motor version V18

Number of stages – Number of stages with smaller impellers	E1	E2	P	Movitec V(C/S)F	
				F1	F2
	[mm]				
1-1	223	166	-	827	487

Dimensions, motor version V1

Number of stages – Number of stages with smaller impellers	E1	E2	P	Movitec V(C/S)F	
				F1	F2
	[mm]				
1	260	190	300	942	577
2-2	260	190	300	1020	655
2	315	260	350	1183	685
3-2	315	260	350	1261	763
3	315	265	350	1341	763
4-2	315	265	350	1421	841
4	360	275	350	1421	841
5-2	360	275	350	1499	919
5	400	340	400	1569	919
6-2	400	340	400	1647	997
6	400	340	400	1647	997
7-2	400	340	400	1725	1075
7	400	340	400	1725	1075
8-2	400	340	400	1803	1153
8	450	365	450	1848	1153
9-2	450	365	450	1926	1231

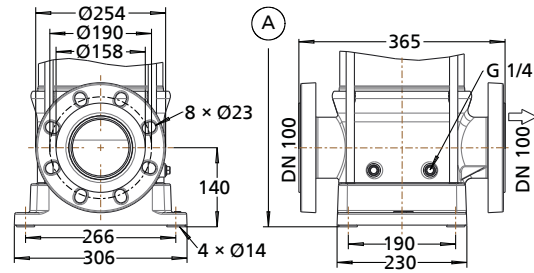

Fig. 57: Movitec VF/VSF; PN 25, 40

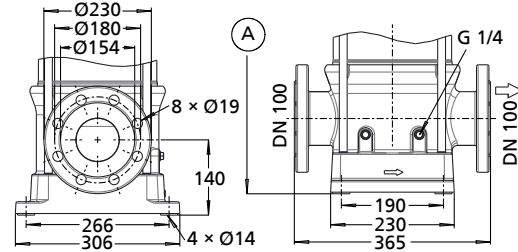

Fig. 58: Movitec VCF; PN 16

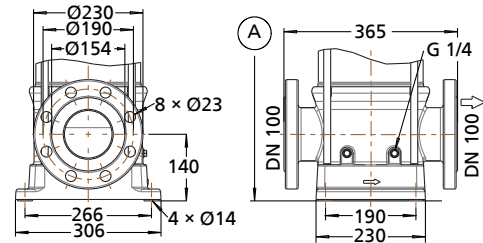

Fig. 59: Movitec VCF; PN 25, 40

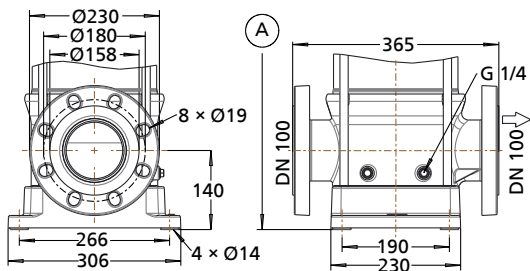
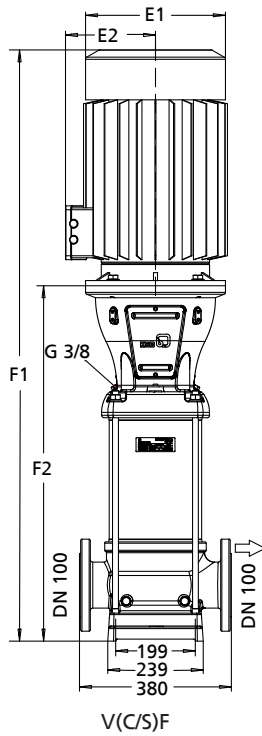

Fig. 56: Movitec VF/VSF; PN 16

Movitec, 90B, n = 1450, 2900 rpm



Dimensions 2900 rpm

Number of stages – Number of stages with smaller impellers	E1	E2	Movitec V(C/S)F	
			F1	F2
			[mm]	
1-1	260	190	970	641
1	260	190	1062	641
2-2	315	260	1282	780
2-1	315	260	1282	780
2	315	260	1282	780
3-2	315	265	1435	889
3-1	360	275	1484	889
3	360	275	1484	889
4-2	400	340	1713	998
4-1	400	340	1713	998
4	400	340	1713	998
5-2	400	340	1822	1107
5-1	400	340	1822	1107
5	400	340	1822	1107
6-2	450	365	1953	1216
6-1	450	365	1953	1216
6	450	365	1953	1216

Dimensions 1450 rpm

Number of stages – Number of stages with smaller impellers	E1	E2	Movitec V(C/S)F	
			F1	F2
			[mm]	
5-2	260	190	1460	1077
5-1	260	190	1460	1077
5	260	190	1460	1077
6-2	260	190	1569	1186
6-1	260	190	1569	1186
6	260	190	1569	1186

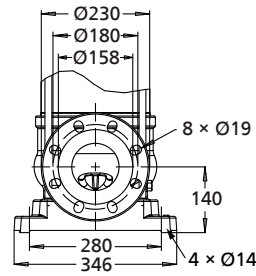

Fig. 60: Movitec VF/VSF, PN 16

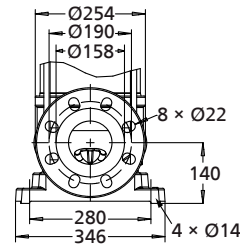

Fig. 61: Movitec VF/VSF, PN 25/40

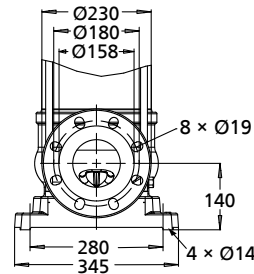

Fig. 62: Movitec VCF, PN 16

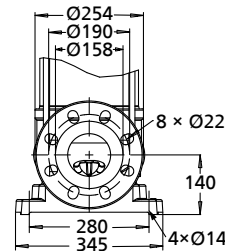
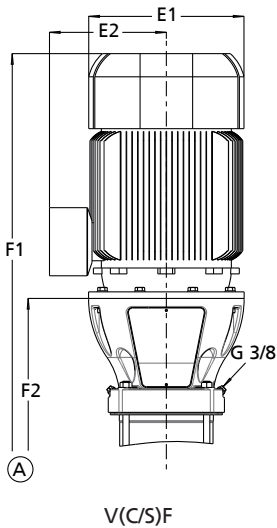

Fig. 63: Movitec VCF, PN 25/40

Movitec, 125B, n = 2900 rpm



Dimensions

Number of stages – Number of stages with smaller impellers	E1	E2	Movitec	
			V(C/S)F	F1
	[mm]			
1	315	260	1244	740
2-2	315	265	1415	867
2-1	360	275	1447	867
2	400	340	1537	867
3-2	400	340	1664	994
3-1	400	340	1664	994
3	400	340	1664	994
4-2	450	365	1831	1121

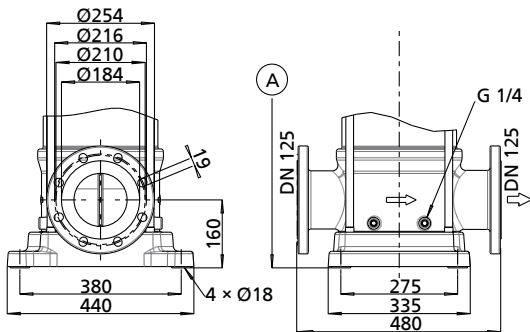

Fig. 64: Movitec VF, VSF, VCF; PN 16

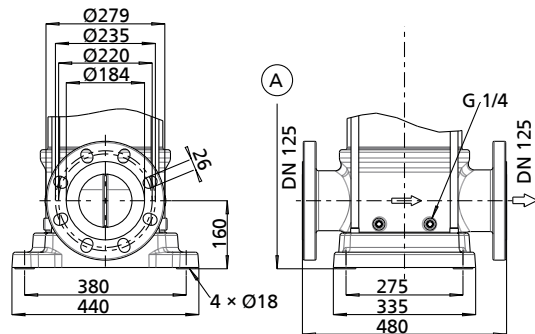
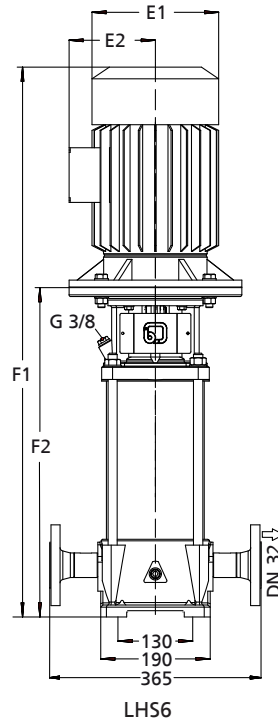

Fig. 65: Movitec VF, VSF, VCF; PN 25/40

Movitec, LHS 6, n = 2900 rpm



Dimensions

Number of stages	E1	E2	F1	F2
10	260	190	928	599
12	260	190	1015	658
14	315	260	1250	718
16	315	260	1310	808
18	315	260	1369	867
20	315	260	1429	927

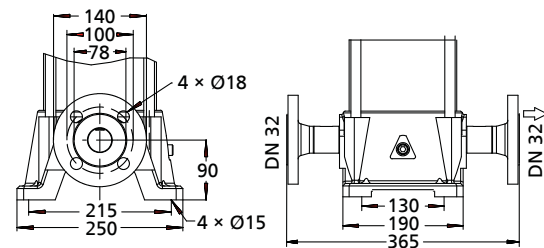

Fig. 66: Movitec LHS 6

Installation information

Standard:

- Vertical installation

(⇒ Page 48)

Optional:

- Horizontal installation

(for motor ratings up to and including 7.5 kW in systems where the installation conditions do not allow vertical installation)

Movitec 2(L)B, 4(L)B, 6(L)B

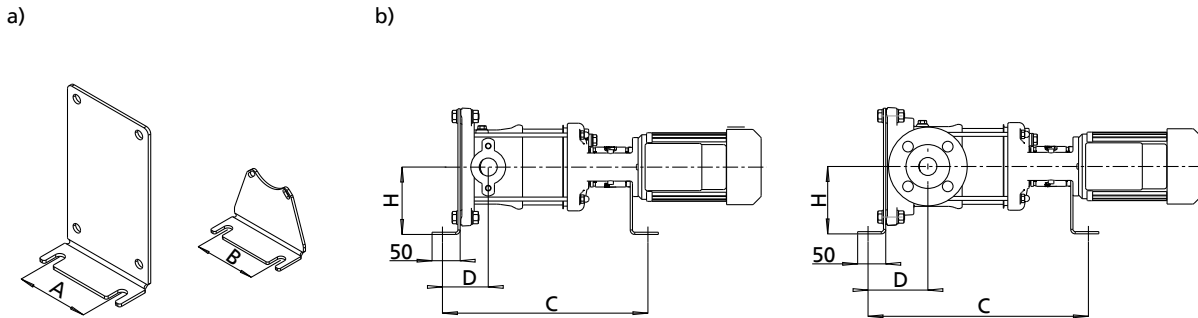

Fig. 67: a) Pump bracket b) Pump set

Installation dimensions of the pump bracket as a function of the motor rating

P_N [kW]	A	B	C ²⁹⁾	D		H	[kg]	Mat. No.
				-, E, T, V	F			
	[mm]							
0,37/0,55 (2 poles)	100	100	F2+49	82	107	120	2	48895741
0,75/1,10 (2 poles)	100	100	F2+49	82	107	120	2,3	48895742
1,50/2,20 (2 poles)	100	100	F2+47	82	107	120	2,5	48895743
3,00/4,00 (2 poles)	100	100	F2+47	82	107	120	3	48895744
5,50/7,50 (2 poles)	100	210	F2-18	82	107	170	3,5	48895745

Movitec 10(L)B, 15(L)B

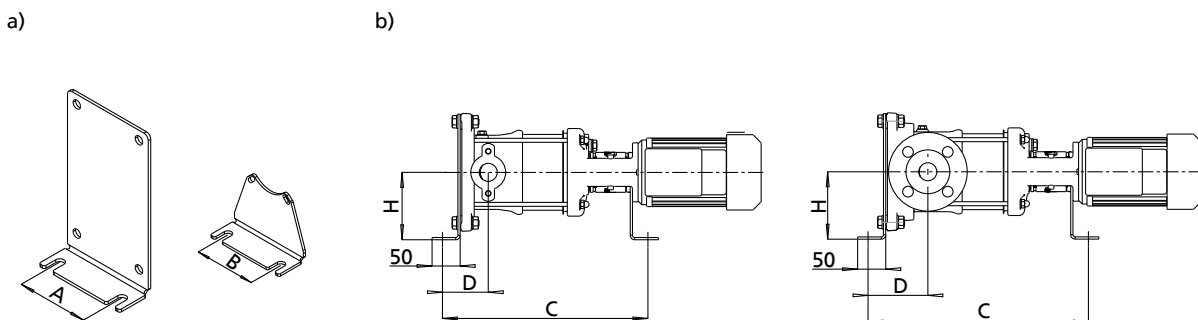

Fig. 68: a) Pump bracket b) Pump set

29) F2: see the section on Dimensions

Installation dimensions of the pump bracket as a function of the motor rating

P_N	A	B	$C^{29)}$	D		H	[kg]	Mat. No.
				-, E, F, T, V 10B -, E 15B	F, T, V 15B			
[kW]	[mm]							
0,75/1,10 (2 poles)	130	130	F2+49	111,5	121,5	140	2,786	01338571
0,55/0,75 (4 poles)								
1,50/2,20 (2 poles)	130	130	F2+47	111,5	121,5	140	2,799	01338572
1,10/1,50 (4 poles)								
3,00/4,00 (2 poles)	130	130	F2+47	111,5	121,5	140	2,766	01338573
2,20/4,00 (4 poles)								
5,50/7,50 (2/4 poles)	130	210	F2-18	111,5	121,5	170	3,116	01338574

Movitec 25B

a)

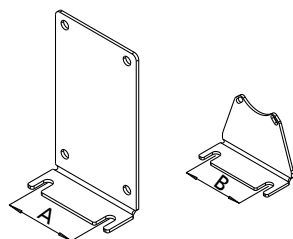

b)

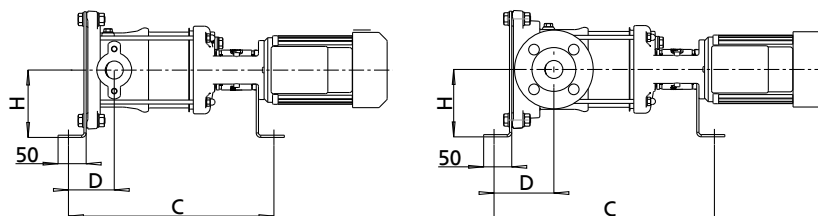
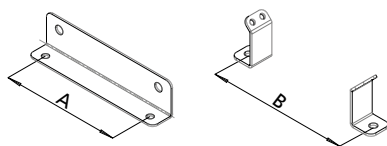

Fig. 69: a) Pump bracket b) Pump set

Installation dimensions of the pump bracket as a function of the motor rating

P_N	A	B	$C^{29)}$	D	H	[kg]	Mat. No.
				[mm]			
1,50/2,20 (2 poles)	170	180	F2+47	136,5	170	2,799	01498693
3,00/4,00 (2 poles)	170	180	F2+47	136,5	170	2,799	01498694
5,50/7,50 (2 poles)	170	210	F2-16	136,5	170	3,116	01498695

Movitec 40B, 60B

a)

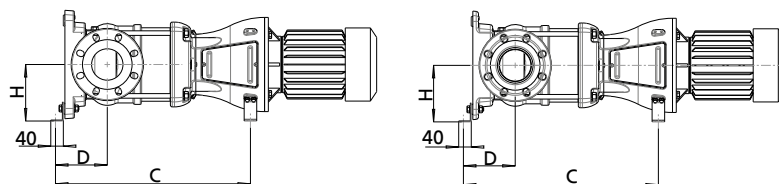

b)

Fig. 70: a) Pump bracket b) Pump set

Installation dimensions of the pump bracket as a function of the motor rating

P_N	A	B	$C^{29)}$	D	H	[kg]	Mat. No.
				[mm]			
3,00/4,00 (2 poles)	190	180	F2-16	165	180	2,799	01582128
2,20/4,00 (4 poles)							
5,50/7,50 (2/4 poles)	190	250	F2-20	165	180	3,116	01582129

Movitec 90B

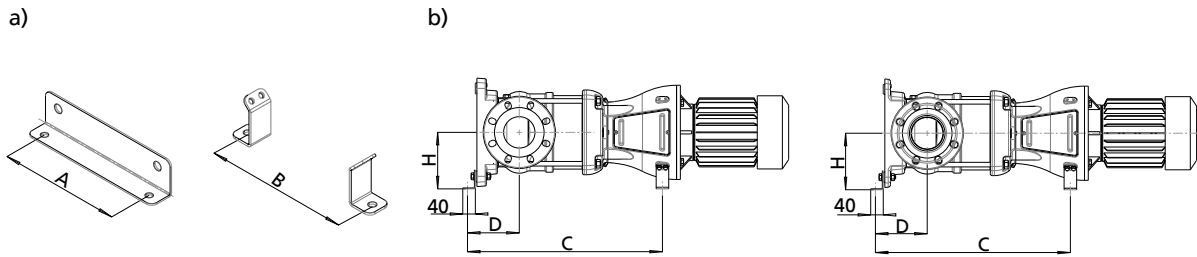

Fig. 71: a) Pump bracket b) Pump set

Installation dimensions of the pump bracket as a function of the motor rating

P_N	A	B	C ²⁹⁾	D	H	[kg]	Mat. No.
[kW]	[mm]						
5,50/7,50 (2/4 poles)	210	250	F2-16	165	180	3,8	48895593

Scope of supply

Depending on the model, the following items are included in the scope of supply:

- Pump
- Electric motor

Accessories

Possible accessories:

- Frequency inverter, see type series booklet PumpDrive (4074.5)

General assembly drawing with list of components

Movitec 2(L)B, 4(L)B, 6(L)B

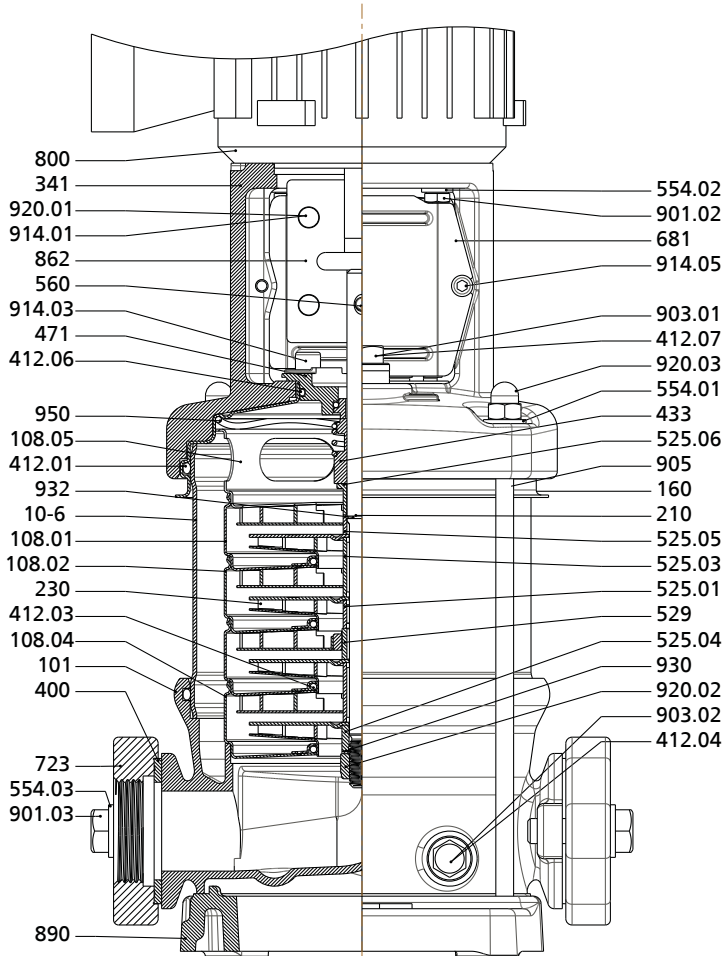

Fig. 72: General assembly drawing of Movitec 2(L)B, 4(L)B, 6(L)B

List of components

Part No.	Description	Part No.	Description
10-6	Pump shroud	560	Pin
101	Pump casing	681	Coupling guard
108	Stage casing	723	Flange
160	Cover	800	Motor
210	Shaft	862	Coupling
230	Impeller	890	Baseplate
341	Drive lantern	901	Hexagon head bolt
400	Gasket	903	Vent plug
412	O-ring	905	Tie bolt
433	Mechanical seal	914	Hexagon socket head cap screw
471	Seal cover	920	Nut
525	Spacer sleeve	930	Safety device
529	Bearing sleeve	932	Circlip
554	Washer	950	Spring

Movitec 10(L)B, 15(L)B

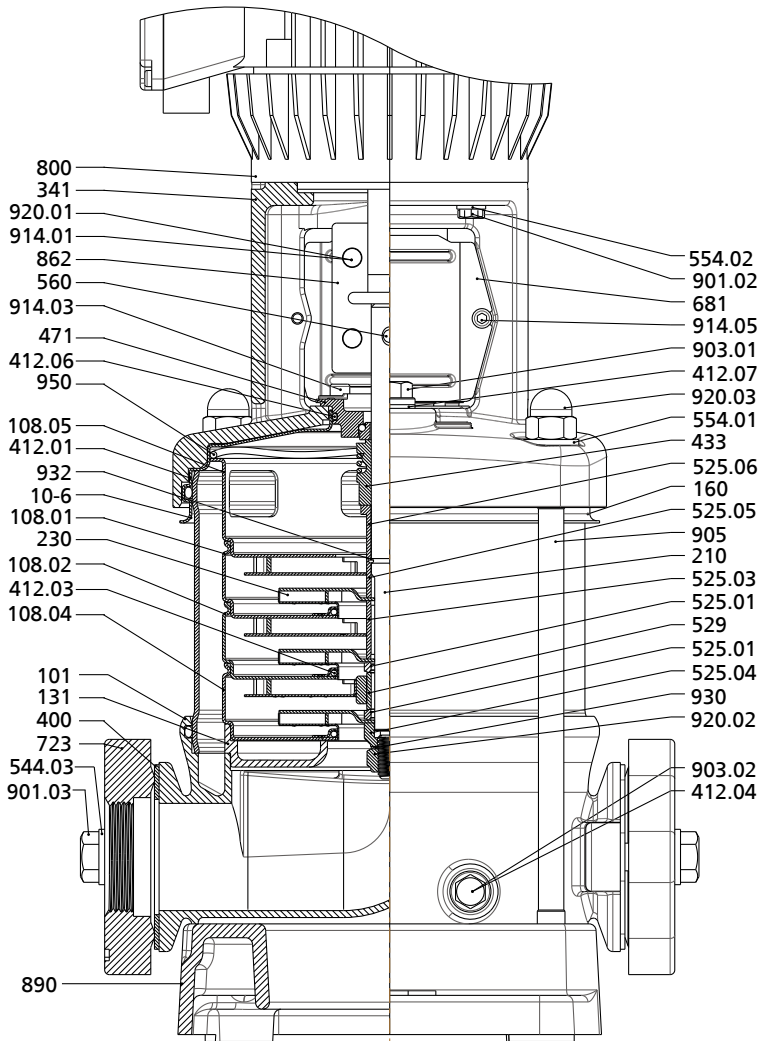

Fig. 73: General assembly drawing of Movitec 10(L)B, 15(L)B

List of components

Part No.	Description	Part No.	Description
10-6	Pump shroud	554	Washer
101	Pump casing	560	Pin
108	Stage casing	681	Coupling guard
131	Inlet ring	723	Flange
160	Cover	800	Motor
210	Shaft	862	Coupling
230	Impeller	890	Baseplate
341	Drive lantern	901	Hexagon head bolt
400	Gasket	903	Vent plug
412	O-ring	905	Tie bolt
433	Mechanical seal	914	Hexagon socket head cap screw
471	Seal cover	920	Nut
525	Spacer sleeve	930	Safety device
529	Bearing sleeve	932	Circlip
544	Threaded bush	950	Spring

Movitec 25B, 40B, 60B

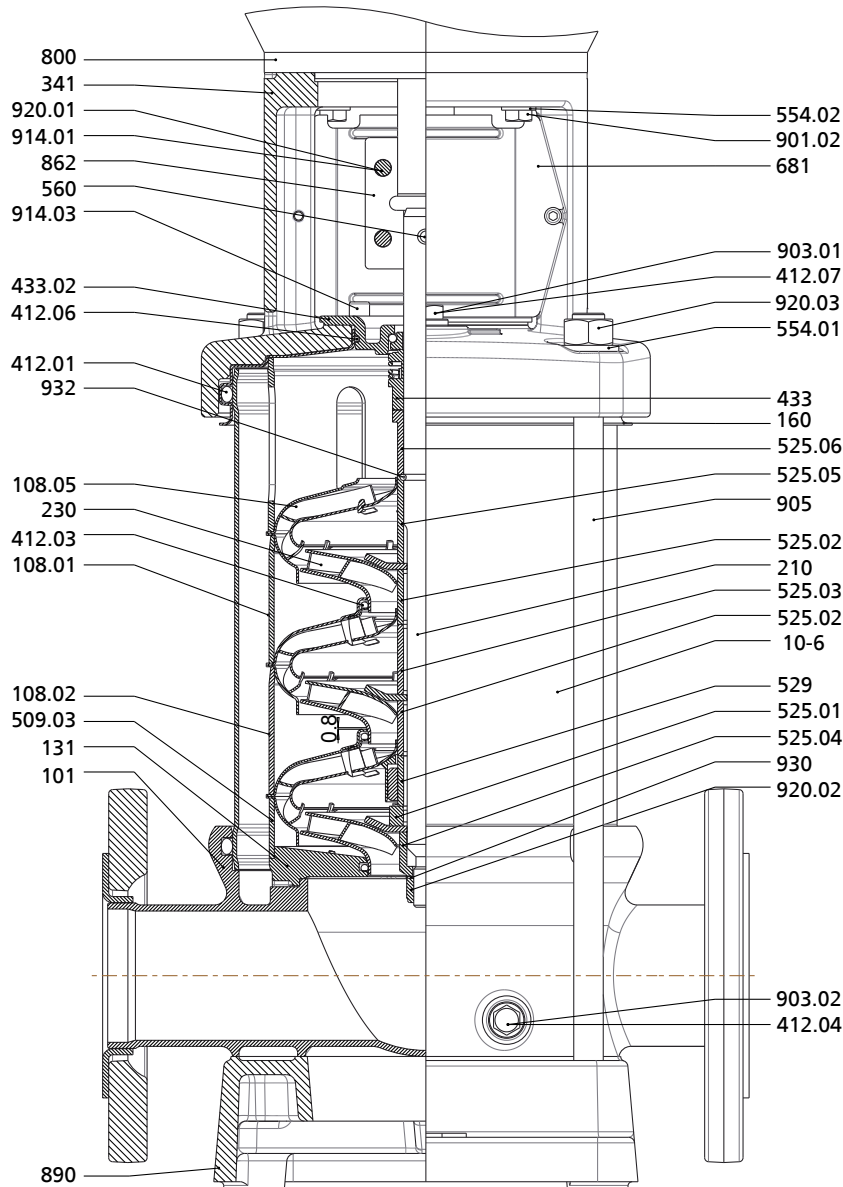

Fig. 74: General assembly drawing of Movitec 25B, 40B, 60B

List of components

Part No.	Description	Part No.	Description
10-6	Pump shroud	554	Washer
101	Pump casing	560	Pin
108	Stage casing	681	Coupling guard
131	Inlet ring	800	Motor
160	Cover	862	Coupling
210	Shaft	890	Baseplate
230	Impeller	901	Hexagon head bolt
341	Drive lantern	903	Vent plug
412	O-ring	905	Tie bolt
433	Mechanical seal	914	Hexagon socket head cap screw
509	Intermediate ring	920	Nut
525	Spacer sleeve	930	Safety device
529	Bearing sleeve	932	Circlip
554	Threaded bush		

Movitec 90B

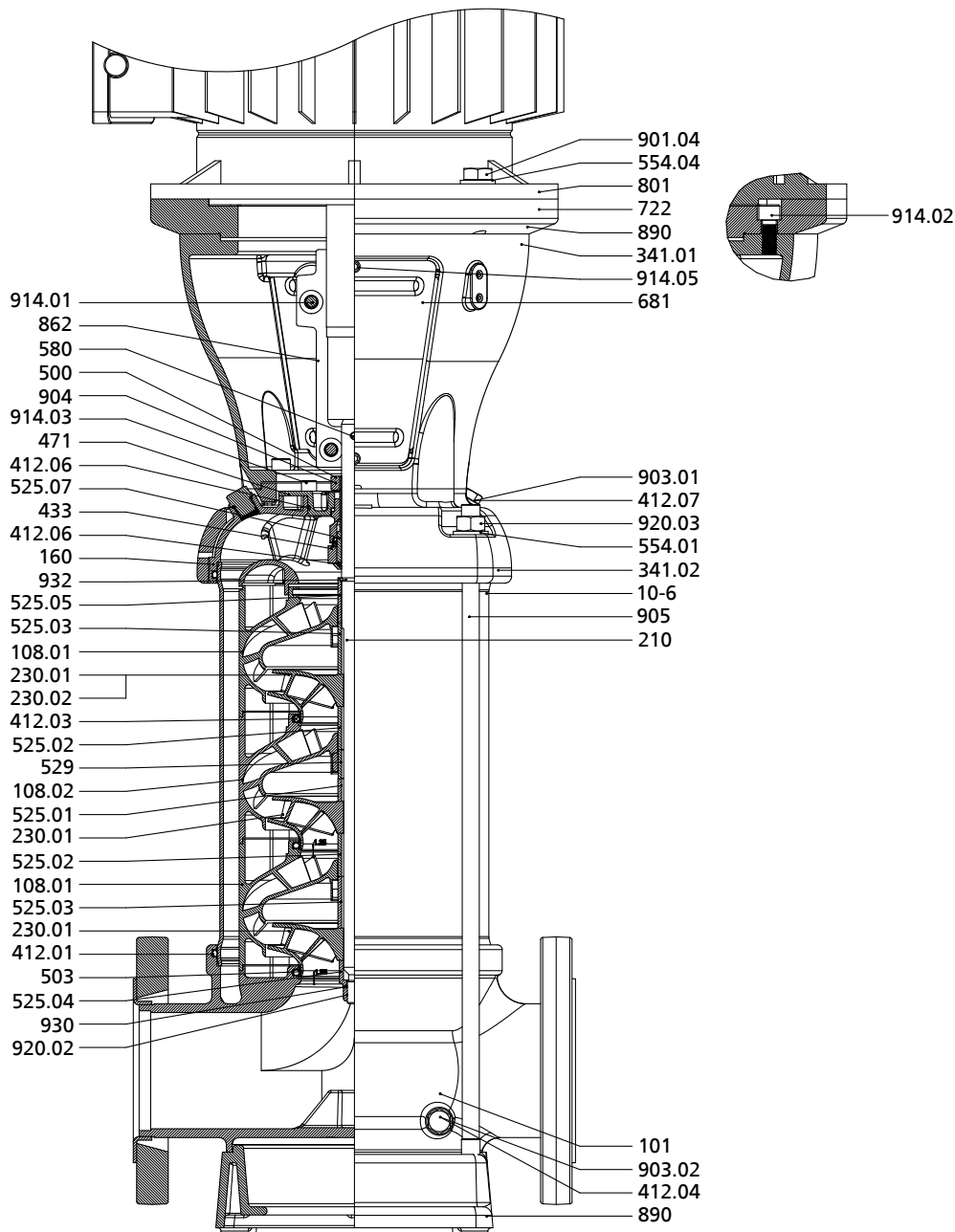

Fig. 75: General assembly drawing of Movitec 90B

List of components

Part No.	Description	Part No.	Description
108	Stage casing	580	Cap
160	Cover	681	Coupling guard
230	Impeller	722	Flange adapter
341	Drive lantern	801	Flanged motor
412	O-ring	862	Coupling
433	Mechanical seal	890	Baseplate
471	Seal cover	901	Hexagon head bolt
500	Ring	904	Grub screw
503	Impeller wear ring	914	Hexagon socket head cap screw
525	Spacer sleeve	920	Nut
529	Bearing sleeve	930	Safety device
554	Washer	932	Circlip

Movitec 125B

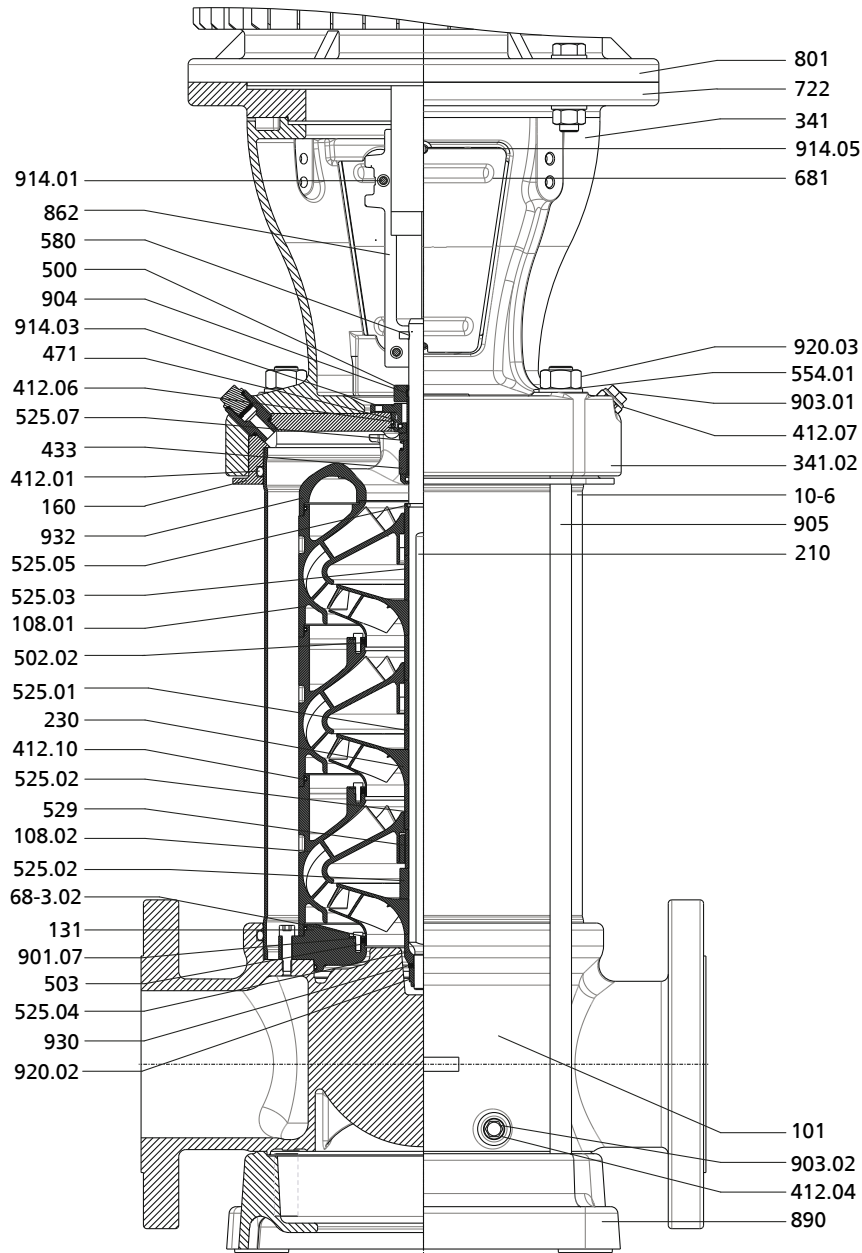

Fig. 76: General assembly drawing of Movitec 125B

List of components

Part No.	Description	Part No.	Description
10-6	Pump shroud	554.01	Washer
101	Pump casing	580	Cap
108.01/.02	Stage casing	68-3.02	Cover plate
131	Inlet ring	681	Coupling guard
160	Cover	722	Flange adapter
210	Shaft	801	Flanged motor
230	Impeller	862	Coupling
341.02	Drive lantern	890	Baseplate
412.01/.04/.06/.07/.10	O-ring	901.07	Hexagon head bolt
433	Mechanical seal	903.01/.02	Screw plug
471	Seal cover	904	Grub screw
500	Ring	905	Tie bolt
502.02	Casing wear ring	914.01/.03/.05	Hexagon socket head cap screw

Part No.	Description	Part No.	Description
503	Impeller wear ring	920.02/.03	Nut
525.01/.02/.03/.04/.05/.07	Spacer sleeve	930	Safety device
529	Bearing sleeve	932	Circlip

Movitec LHS 6

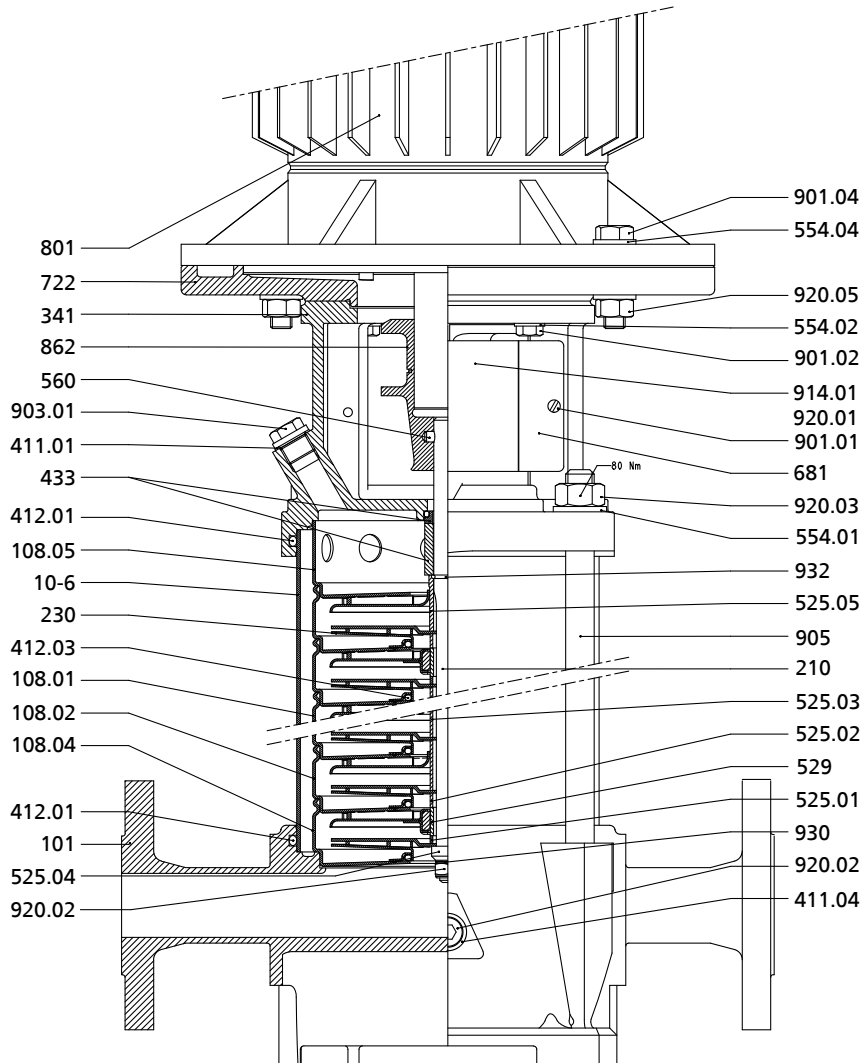

Fig. 77: General assembly drawing of Movitec LHS 6

List of components

Part No.	Description	Part No.	Description
10-6	Pump shroud	560	Pin
101	Pump casing	681	Coupling guard
108	Stage casing	722	Flange adapter
210	Shaft	801	Flanged motor
230	Impeller	862	Coupling
341	Drive lantern	901	Hexagon head bolt
411	Joint ring	903	Vent plug
412	O-ring	905	Tie bolt
433	Mechanical seal	914	Hexagon socket head cap screw
525	Spacer sleeve	920	Nut
529	Bearing sleeve	930	Safety device
554	Washer	932	Circlip



KSB SE & Co. KGaA
Johann-Klein-Straße 9 • 67227 Frankenthal (Germany)
Tel. +49 6233 86-0
www.ksb.com